

2651A

- **Source or sink:**
 - 2,000W of pulsed power ($\pm 40V$, $\pm 50A$)
 - 200W of DC power ($\pm 10V@ \pm 20A$, $\pm 20V@ \pm 10A$, $\pm 40V@ \pm 5A$)
- Easily connect two units (in series or parallel) to create solutions up to $\pm 100A$ or $\pm 80V$
- 1pA resolution enables precise measurement of very low leakage currents
- 1 μ s per point (1MHz), 18-bit sampling, accurately characterizes transient behavior
- 1% to 100% pulse duty cycle for pulse width modulated (PWM) drive schemes and device-specific drive stimulus
- Combines a precision power supply, current source, DMM, arbitrary waveform generator, V or I pulse generator with measurement, electronic load, and trigger controller—all in one instrument
- Includes TSP[®] Express I-V characterization software, LabVIEW[®] driver, and Keithley's Test Script Builder software development environment

APPLICATIONS

- Power semiconductor, HBLED, and optical device characterization and testing
- Solar cell characterization and testing
- Characterization of GaN, SiC, and other compound materials and devices
- Semiconductor junction temperature characterization
- High speed, high precision digitization
- Electromigration studies
- High current, high power device testing

50A, High Power System SourceMeter[®] SMU Instrument



The high power Model 2651A SourceMeter SMU Instrument is specifically designed to characterize and test high power electronics. This SMU instrument can help you improve productivity in applications across the R&D, reliability, and production spectrums, including high brightness LEDs, power semiconductors, DC-DC converters, batteries, solar cells, and other high power materials, components, modules, and subassemblies.

The Model 2651A offers a highly flexible, four-quadrant voltage and current source/load coupled with precision voltage and current meters. It can be used as a:

- Semiconductor characterization instrument
- V or I waveform generator
- V or I pulse generator
- Precision power supply
- True current source
- Digital multimeter (DCV, DCI, ohms, and power with 6½-digit resolution)
- Precision electronic load

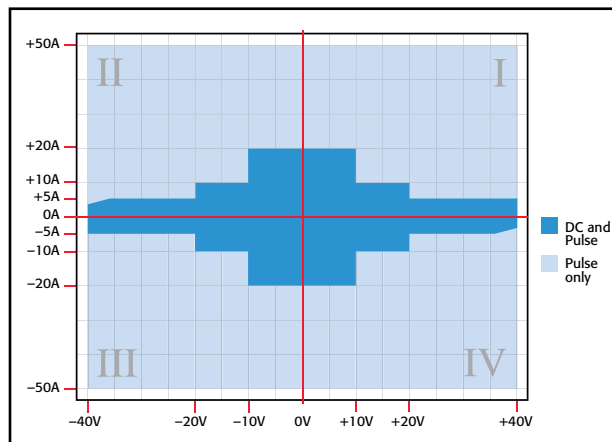

The Model 2651A can source or sink up to $\pm 40V$ and $\pm 50A$.

Two Measurement Modes: Digitizing or Integrating

Precisely characterize transient and steady-state behavior, including rapidly changing thermal effects, with the two measurement modes in the Model 2651A. Each mode is defined by its independent analog-to-digital (A/D) converters.

The Digitizing Measurement mode enables 1 μ s per point measurements. Its 18-bit A/D converters allow you to precisely measure transient characteristics. For more accurate measurements, use its Integrating Measurement mode, which is based on 22-bit A/D converters.



敏盛企業有限公司

<http://www.mavin.com.tw>

免責聲明

資料僅供參考，若有與原廠不合之處，請以原廠規格為準，且不供任何證明文件之用

TEL:03-5970828 FAX:03-5972622 新竹湖口工業區工業四路3號2F

KEITHLEY

A Tektronix Company

2651A

Ordering Information

2651A High Power System SourceMeter® SMU Instrument

Accessories Supplied

2651A-KIT-1A: Low Impedance Cable Assembly (1m)

CS-1592-2: High Current Phoenix Connector (male)

CS-1626-2: High Current Phoenix Connector (female)

CA-557-1: Sense Line Cable Assembly (1m)

7709-308A: Digital I/O Connector

CA-180-3A: TSP-Link/Ethernet Cable

Documentation CD

Software Tools and Drivers CD

ACCESSORIES AVAILABLE

2600-KIT	Screw Terminal Connector Kit
ACS-BASIC	Component Characterization Software
4299-6	Rack Mount Kit
8011	Test Socket Kit

Two A/D converters are used with each measurement mode (one for current and the other for voltage), which run simultaneously for accurate source readback that does not sacrifice test throughput.

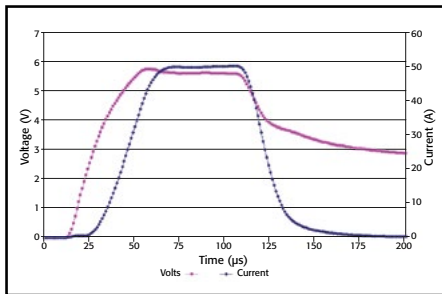

The dual digitizing A/D converters sample at up to 1µs/point, enabling full simultaneous characterization of both current and voltage waveforms.

High Speed Pulsing

The Model 2651A minimizes the unwanted effects of self heating during tests by accurately sourcing and measuring pulses as short as 100µs. Additional control flexibility enables you to program the pulse width from 100µs to DC and the duty cycle from 1% to 100%. A single

50A, High Power System SourceMeter® SMU Instrument

unit can pulse up to 50A; combine two units to pulse up to 100A.

Expansion Capabilities

Through TSP-Link Technology technology, multiple Model 2651As and selected Series 2600B SMU instruments can be combined to form a larger integrated system with up to 64 channels. Precision timing and tight channel synchronization are guaranteed with built-in 500ns trigger controllers. True SMU instrument-per-pin testing is assured with the fully isolated, independent channels of the SourceMeter SMU instruments.

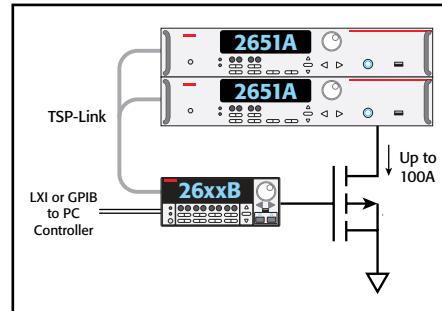

Keithley's TSP and TSP-Link Technologies enable true SMU-per-pin testing without the power and/or channel limitations of a mainframe-based system.

Also, when two Model 2651As are connected in parallel with TSP-Link Technology, the current range is expanded from 50A to 100A. When two units are connected in series, the voltage range is expanded from 40V to 80V. Built-in intelligence simplifies testing by enabling the units to be addressed as a single instrument, thus creating an industry-best dynamic range (100A to 1pA). This capability enables you to test a much wider range of power semiconductors and other devices.

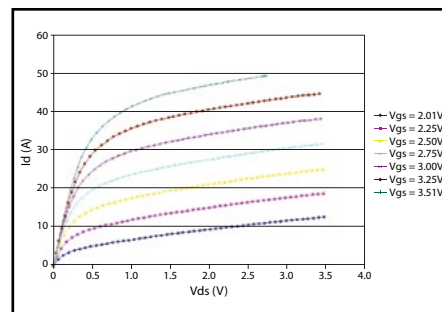

Precision measurements to 50A (100A with two units) enable a more complete and accurate characterization.

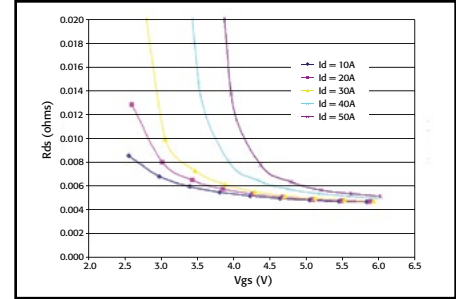

1µV measurement resolution and current sourcing up to 50A (100A with two units) enable low-level Rds measurements to support next-generation devices.

Standard Capabilities of Series 2600B SMU Instruments

Each Model 2651A includes all the features and capabilities provided in most Series 2600B SMU instruments, such as:

- Ability to be used as either a bench-top I-V characterization tool or as a building block component of multiple-channel I-V test systems
- TSP Express software to quickly and easily perform common I-V tests without programming or installing software
- ACS Basic Edition software for semiconductor component characterization (optional). ACS Basic now features a Trace mode for generating a suite of characteristic curves.
- Keithley's Test Script Processor (TSP®) Technology, which enables creation of custom user test scripts to further automate testing, and also supports the creation of programming sequences that allow the instrument to operate asynchronously without direct PC control.
- Parallel test execution and precision timing when multiple SMU instruments are connected together in a system
- LXI compliance
- 14 digital I/O lines for direct interaction with probe stations, component handlers, or other automation tools
- USB port for extra data and test program storage via USB memory device

2651A

50A, High Power System SourceMeter® SMU Instrument

Specification Conditions

This document contains specifications and supplemental information for the Model 2651A High Power System SourceMeter SMU instrument. Specifications are the standards against which the Model 2651A is tested. Upon leaving the factory, the Model 2651A meets these specifications. Supplemental and typical values are non-warranted, apply at 23°C, and are provided solely as useful information.

Accuracy specifications are applicable for both normal and high-capacitance modes.

Source and measurement accuracies are specified at the Model 2651A terminals under these conditions:

- 23° ±5°C, <70 percent relative humidity
- After two-hour warm-up
- Speed normal (1 NPLC)
- A/D autozero enabled
- Remote sense operation or properly zeroed local operation
- Calibration period: One year

VOLTAGE ACCURACY SPECIFICATIONS 1, 2

Range	SOURCE			MEASURE		
	Programming Resolution	Accuracy ±(% reading + volts)	Noise (Vpp) (typical) 0.1 Hz to 10 Hz	Default Display Resolution	Integrating ADC Accuracy ³ ±(% reading + volts)	High-Speed ADC Accuracy ⁴ ±(% reading + volts)
100.000 mV	5 μV	0.02% + 500 μV	100 μV	1 μV	0.02% + 300 μV	0.05% + 600 μV
1.00000 V	50 μV	0.02% + 500 μV	500 μV	10 μV	0.02% + 300 μV	0.05% + 600 μV
10.0000 V	500 μV	0.02% + 5 mV	1 mV	100 μV	0.02% + 3 mV	0.05% + 8 mV
20.0000 V	500 μV	0.02% + 5 mV	1 mV	100 μV	0.02% + 5 mV	0.05% + 8 mV
40.0000 V	500 μV	0.02% + 12 mV	2 mV	100 μV	0.02% + 12 mV	0.05% + 15 mV

CURRENT ACCURACY SPECIFICATIONS 5

Range	SOURCE			MEASURE		
	Programming Resolution	Accuracy ±(% reading + amps)	Noise (Ipp) (typical) 0.1Hz to 10Hz	Default Display Resolution	Integrating ADC Accuracy ³ ±(% reading + amps)	High-Speed ADC Accuracy ⁴ ±(% reading + amps)
100.000 nA	2 pA	0.1 % + 500 pA	50 pA	1 pA	0.08% + 500 pA	0.08% + 800 pA
1.00000 μA	20 pA	0.1 % + 2 nA	250 pA	10 pA	0.08% + 2 nA	0.08% + 4 nA
10.0000 μA	200 pA	0.1 % + 10 nA	500 pA	100 pA	0.08% + 8 nA	0.08% + 10 nA
100.000 μA	2 nA	0.03% + 60 nA	5 nA	1 nA	0.02% + 25 nA	0.05% + 60 nA
1.00000 mA	20 nA	0.03% + 300 nA	10 nA	10 nA	0.02% + 200 nA	0.05% + 500 nA
10.0000 mA	200 nA	0.03% + 8 μA	500 nA	100 nA	0.02% + 2.5 μA	0.05% + 10 μA
100.000 mA	2 μA	0.03% + 30 μA	1 μA	1 μA	0.02% + 20 μA	0.05% + 50 μA
1.00000 A	200 μA	0.08% + 3.5 mA	300 μA	10 μA	0.05% + 3 mA	0.05% + 5 mA
5.00000 A	200 μA	0.08% + 3.5 mA	300 μA	10 μA	0.05% + 3 mA	0.05% + 5 mA
10.0000 A	500 μA	0.15% + 6 mA	500 μA	100 μA	0.12% + 6 mA	0.12% + 12 mA
20.0000 A	500 μA	0.15% + 8 mA	500 μA	100 μA	0.08% + 8 mA	0.08% + 15 mA
50.0000 A ⁶	2 mA	0.15% + 80 mA	N/A	100 μA	0.05% + 50 mA ⁷	0.05% + 90 mA ⁸

NOTES

1. Add 50μV to source accuracy specifications per volt of HI lead drop.
2. For temperatures 0° to 18°C and 28° to 50°C, accuracy is degraded by ±(0.15 × accuracy specification)/°C. High-capacitance mode accuracy is applicable at 23° ±5°C only.
3. Derate accuracy specification for NPLC setting <1 by increasing error term. Add appropriate typical percent of range term for resistive loads using the table below.

NPLC Setting	100mV Range	1V to 40V Ranges	100nA Range	1μA to 100mA Ranges	1A to 20A Ranges
0.1	0.01%	0.01%	0.01%	0.01%	0.01%
0.01	0.08%	0.07%	0.1 %	0.05%	0.1 %
0.001	0.8 %	0.6 %	1 %	0.5 %	1.8 %

4. 18-bit ADC. Average of 1000 samples taken at 1μs intervals.
5. At temperatures 0° to 18°C and 28° to 50°C, 100nA to 10μA accuracy is degraded by ±(0.35 × accuracy specification)/°C. 100μA to 50A accuracy is degraded by ±(0.15 × accuracy specification)/°C. High-capacitance mode accuracy is applicable at 23° ±5°C only.
6. 50A range accessible only in pulse mode.
7. 50A range accuracy measurements are taken at 0.008 NPLC.
8. Average of 100 samples taken at 1μs intervals.

2651A

50A, High Power System SourceMeter® SMU Instrument

DC POWER SPECIFICATIONS

MAXIMUM OUTPUT POWER: 202W maximum.

SOURCE/SINK LIMITS¹:

- Voltage:** $\pm 10.1\text{V}$ at $\pm 20.0\text{A}$, $\pm 20.2\text{V}$ at $\pm 10.0\text{A}$, $\pm 40.4\text{V}$ at $\pm 5.0\text{A}$ ².
Four-quadrant source or sink operation.
- Current:** $\pm 5.05\text{A}$ at $\pm 40\text{V}$ ², $\pm 10.1\text{A}$ at $\pm 20\text{V}$, $\pm 20.2\text{A}$ at $\pm 10\text{V}$.
Four-quadrant source or sink operation.

CAUTION: Carefully consider and configure the appropriate output-off state and source and compliance levels before connecting the Model 2651A to a device that can deliver energy. Failure to consider the output-off state and source and compliance levels may result in damage to the instrument or to the device under test.

PULSE SPECIFICATIONS

MINIMUM PROGRAMMABLE PULSE WIDTH³: $100\mu\text{s}$. Note: Minimum pulse width for settled source at a given I/V output and load can be longer than $100\mu\text{s}$.

PULSE WIDTH PROGRAMMING RESOLUTION: $1\mu\text{s}$.

PULSE WIDTH PROGRAMMING ACCURACY³: $\pm 5\mu\text{s}$.

PULSE WIDTH JITTER: $2\mu\text{s}$ (typical).

PULSE RISE TIME (TYPICAL):

Current Range	R_{load}	Rise Time (typical)
50 A	$0.05\ \Omega$	$26\ \mu\text{s}$
50 A	$0.2\ \Omega$	$57\ \mu\text{s}$
50 A	$0.4\ \Omega$	$85\ \mu\text{s}$
20 A	$0.5\ \Omega$	$95\ \mu\text{s}$
50 A	$0.8\ \Omega$	$130\ \mu\text{s}$
20 A	$1\ \Omega$	$180\ \mu\text{s}$
10 A	$2\ \Omega$	$330\ \mu\text{s}$
5 A	$8.2\ \Omega$	$400\ \mu\text{s}$

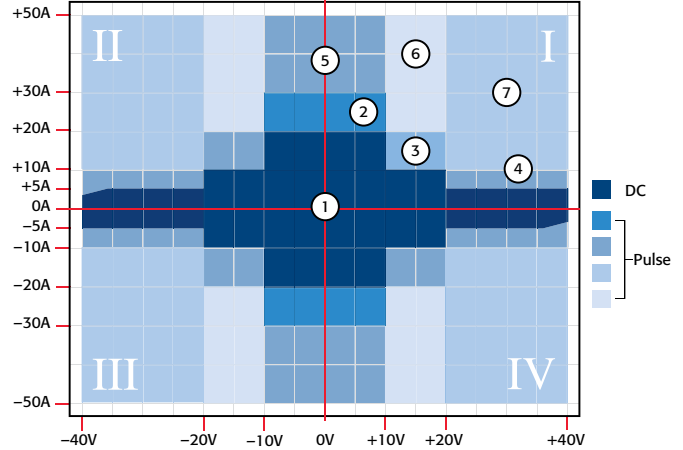

Region	Region Maximums	Maximum Pulse Width ³	Maximum Duty Cycle ⁴
1	5 A at 40 V	DC, no limit	100%
1	10 A at 20 V	DC, no limit	100%
1	20 A at 10 V	DC, no limit	100%
2	30 A at 10 V	1 ms	50%
3	20 A at 20 V	1.5 ms	40%
4	10 A at 40 V	1.5 ms	40%
5	50 A at 10 V	1 ms	35%
6	50 A at 20 V	$330\ \mu\text{s}$	10%
7	50 A at 40 V	$300\ \mu\text{s}$	1%

NOTES

- Full power source operation regardless of load to 30°C ambient. Above 30°C or power sink operation, refer to "Operating Boundaries" in the Model 2651A Reference manual for additional power derating information.
- Quadrants 2 and 4 power envelope is trimmed at 36V and 4.5A .
- Times measured from the start of pulse to the start of off-time; see figure below.

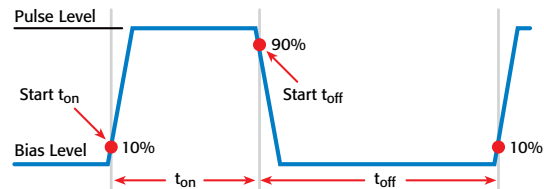

- Thermally limited in sink mode (quadrants 2 and 4) and ambient temperatures above 30°C . See power equations in the Model 2651A Reference Manual for more information.



The Model 2651A supports GPIB, LXI, Digital I/O, and Keithley's TSP-Link Technology for multi-channel synchronization.

2651A

50A, High Power System SourceMeter® SMU Instrument

ADDITIONAL SOURCE SPECIFICATIONS

NOISE (10Hz to 20MHz): <100mV peak-peak (typical), <30mV RMS (typical), 10V range with a 20A limit.

OVERSHOOT:

Voltage: <±(0.1% + 10mV) (typical). Step size = 10% to 90% of range, resistive load, maximum current limit/compliance.

Current: <±(0.1% + 10mV) (typical). Step Size = 10% to 90% of range, resistive load. See Current Source Output Settling Time specifications for additional test conditions.

RANGE CHANGE OVERSHOOT:

Voltage: <300mV + 0.1% of larger range (for <20V ranges) (typical).

<400mV + 0.1% of larger range (for ≥20V ranges) (typical).
Overshoot into a 100kΩ load, 20MHz bandwidth.

Current: <5% of larger range + 360mV/R_{load} (for >10μA ranges) (typical). I_{out} × R_{load} = 1V.

VOLTAGE SOURCE OUTPUT SETTLING TIME: Time required to reach within 0.1% of final value after source level command is processed on a fixed range.¹

Range	Settling Time (typical)
1 V	< 70 μs
10 V	<160 μs
20 V	<190 μs
40 V	<175 μs

CURRENT SOURCE OUTPUT SETTLING TIME: Time required to reach within 0.1% of final value after source level command is processed on a fixed range. Values below for I_{out} × R_{load}.

Current Range	R _{load}	Settling time (typical)
20 A	0.5 Ω	<195 μs
10 A	1.5 Ω	<540 μs
5 A	5 Ω	<560 μs
1 A	1 Ω	< 80 μs
100 mA	10 Ω	< 80 μs
10 mA	100 Ω	<210 μs
1 mA	1 kΩ	<300 μs
100 μA	10 kΩ	<500 μs
10 μA	100 kΩ	< 15 ms
1 μA	1 MΩ	< 35 ms
100 nA	10 MΩ	<110 ms

TRANSIENT RESPONSE TIME:

10V and 20V Ranges: <70μs for the output to recover to within 0.1% for a 10% to 90% step change in load.

40V Range: <110μs for the output to recover to within 0.1% for a 10% to 90% step change in load.

GUARD OFFSET VOLTAGE: <4mV, current <10mA.

REMOTE SENSE OPERATING RANGE²:

Maximum Voltage between HI and SENSE HI: 3V.

Maximum Voltage between LO and SENSE LO: 3V.

MAXIMUM IMPEDANCE PER SOURCE LEAD:

Maximum impedance limited by 3V drop by remote sense operating range.

Maximum resistance = 3V/source current value (amperes) (maximum of 1Ω per source lead).

3V = I di/dt.

VOLTAGE OUTPUT HEADROOM:

5A Range: Maximum output voltage = 48.5V – (Total voltage drop across source leads).

10A Range: Maximum output voltage = 24.5V – (Total voltage drop across source leads).

20A Range: Maximum output voltage = 15.9V – (Total voltage drop across source leads).

OVERTEMPERATURE PROTECTION: Internally sensed temperature overload puts unit in standby mode.

LIMIT/COMPLIANCE: Bipolar limit (compliance) set with single value.

Voltage³: Minimum value is 10mV; accuracy is the same as voltage source.

Current⁴: Minimum value is 10nA; accuracy is the same as current source.

NOTES

- With measure and compliance set to the maximum current for the specified voltage range.
- Add 50μV to source accuracy specifications per volt of HI lead drop.
- For sink mode operation (quadrants II and IV), add 0.6% of limit range to the corresponding voltage source accuracy specifications. For 100mV range add an additional 60mV of uncertainty. Specifications apply with sink mode enabled.
- For sink mode operation (quadrants II and IV), add 0.6% of limit range to the corresponding current limit accuracy specifications. Specifications apply with sink mode enabled.

ADDITIONAL MEASUREMENT SPECIFICATIONS

CONTACT CHECK¹

Speed	Maximum Measurement Time to Memory for 60Hz (50Hz)	Accuracy (1 Year) 23° ± 5°C ±(% reading + ohms)
Fast	1.1 ms (1.2 ms)	5% + 15 Ω
Medium	4.1 ms (5 ms)	5% + 5 Ω
Slow	36 ms (42 ms)	5% + 3 Ω

NOTES

- Includes measurement of SENSE HI to HI and SENSE LO to LO contact resistances.

ADDITIONAL METER SPECIFICATIONS

MAXIMUM LOAD IMPEDANCE:

Normal Mode: 10nF (typical), 3μH (typical).

High-Capacitance Mode: 50μF (typical), 3μH (typical).

COMMON MODE VOLTAGE: 250V DC.

COMMON MODE ISOLATION: >1GΩ, <4500pF.

MEASURE INPUT IMPEDANCE: >10GΩ.

SENSE HIGH INPUT IMPEDANCE: >10GΩ.

MAXIMUM SENSE LEAD RESISTANCE: 1kΩ for rated accuracy.

OVERRRANGE: 101% of source range, 102% of measure range.

HIGH-CAPACITANCE MODE^{1,2}

ACCURACY SPECIFICATIONS³: Accuracy specifications are applicable in both normal and high-capacitance modes.

VOLTAGE SOURCE OUTPUT SETTLING TIME: Time required to reach within 0.1% of final value after source level command is processed on a fixed range.⁴

Voltage Source Range	Settling Time with C _{load} = 4.7μF (typical)
1 V	75 μs
10 V	170 μs
20 V	200 μs
40 V	180 μs

MODE CHANGE DELAY:

100μA Current Range and Above:

Delay into High-Capacitance Mode: 11ms.

Delay out of High-Capacitance Mode: 11ms.

1μA and 10μA Current Ranges:

Delay into High-Capacitance Mode: 250ms.

Delay out of High-Capacitance Mode: 11ms.

MEASURE INPUT IMPEDANCE: >10GΩ in parallel with 25nF.

VOLTAGE SOURCE RANGE CHANGE OVERSHOOT: <400mV + 0.1% of larger range (typical).
Overshoot into a 100kΩ load, 20MHz bandwidth.

NOTES

- High-capacitance mode specifications are for DC measurements only and use locked ranges. Autorange is disabled.
- 100nA range is not available in high-capacitance mode.
- Add an additional 2nA to the source current accuracy and measure current accuracy offset for the 1μA range.
- With measure and compliance set to the maximum current for the specified voltage range.

2651A

50A, High Power System SourceMeter® SMU Instrument

MEASUREMENT SPEED SPECIFICATIONS ^{1, 2}

MAXIMUM SWEEP OPERATION RATES (operations per second) FOR 60Hz (50Hz):

A/D Converter Speed	Trigger Origin	Measure To Memory Using User Scripts	Measure To GPIB Using User Scripts	Source Measure To Memory Using User Scripts	Source Measure To GPIB Using User Scripts	Source Measure To Memory Using Sweep API	Source Measure To GPIB Using Sweep API
0.001 NPLC	Internal	20000 (20000)	9800 (9800)	7000 (7000)	6200 (6200)	12000 (12000)	5900 (5900)
0.001 NPLC	Digital I/O	8100 (8100)	7100 (7100)	5500 (5500)	5100 (5100)	11200 (11200)	5700 (5700)
0.01 NPLC	Internal	4900 (4000)	3900 (3400)	3400 (3000)	3200 (2900)	4200 (3700)	4000 (3500)
0.01 NPLC	Digital I/O	3500 (3100)	3400 (3000)	3000 (2700)	2900 (2600)	4150 (3650)	3800 (3400)
0.1 NPLC	Internal	580 (480)	560 (470)	550 (465)	550 (460)	560 (470)	545 (460)
0.1 NPLC	Digital I/O	550 (460)	550 (460)	540 (450)	540 (450)	560 (470)	545 (460)
1.0 NPLC	Internal	59 (49)	59 (49)	59 (49)	59 (49)	59 (49)	59 (49)
1.0 NPLC	Digital I/O	58 (48)	58 (49)	59 (49)	59 (49)	59 (49)	59 (49)
HS ADC	Internal	38500 (38500)	18000 (18000)	10000 (10000)	9500 (9500)	14300 (14300)	6300 (6300)
HS ADC	Digital I/O	12500 (12500)	11500 (11500)	7500 (7500)	7000 (7000)	13200 (13200)	6000 (6000)

HIGH SPEED ADC BURST MEASUREMENT RATES ³

Burst Length (readings)	Readings per Second	Bursts per Second
100	1,000,000	400
500	1,000,000	80
1000	1,000,000	40
2500	1,000,000	16
5000	1,000,000	8

MAXIMUM SINGLE MEASUREMENT RATES (operations per second) FOR 60Hz (50Hz)

A/D Converter Speed	Trigger Origin	Measure To GPIB	Source Measure To GPIB	Source Measure Pass/Fail To GPIB
0.001 NPLC	Internal	1900 (1800)	1400 (1400)	1400 (1400)
0.01 NPLC	Internal	1450 (1400)	1200 (1100)	1100 (1100)
0.1 NPLC	Internal	450 (390)	425 (370)	425 (375)
1.0 NPLC	Internal	58 (48)	57 (48)	57 (48)

MAXIMUM MEASUREMENT RANGE CHANGE RATE: >4000 per second for >10 μ A (typical).

MAXIMUM SOURCE RANGE CHANGE RATE: >325 per second for >10 μ A, typical. When changing to or from a range \geq 1A, maximum rate is >250 per second, typical.

COMMAND PROCESSING TIME: Maximum time required for the output to begin to change following the receipt of the smua.source.levelv or smua.source.leveli command. <1ms typical.

NOTES

1. Tests performed with a Model 2651A on channel A using the following equipment: Computer hardware (Intel® Pentium® 4 2.4GHz, 2GB RAM, National Instruments™ PCI-GPIB), Driver (NI-488.2 Version 2.2 PCI-GPIB), Software (Microsoft® Windows® XP, Microsoft Visual Studio® 2010, VISA™ version 4.1).
2. Exclude current measurement ranges less than 1mA.
3. smua.measure.adc has to be enabled and the smua.measure.count set to the burst length.

TRIGGERING AND SYNCHRONIZATION SPECIFICATIONS

TRIGGERING:

- Trigger In to Trigger Out: 0.5 μ s (typical).
- Trigger In to Source Change ¹: 10 μ s (typical).
- Trigger Timer Accuracy: \pm 2 μ s (typical).
- Source Change ¹ After LXI Trigger: 280 μ s (typical).

SYNCHRONIZATION:

- Single-Node Synchronized Source Change ¹: <0.5 μ s (typical).
- Multi-Node Synchronized Source Change ¹: <0.5 μ s (typical).

NOTES

1. Fixed source range with no polarity change.

2651A

50A, High Power System SourceMeter[®] SMU Instrument

SUPPLEMENTAL INFORMATION

FRONT PANEL INTERFACE: Two-line vacuum fluorescent display (VFD) with keypad and navigation wheel.

DISPLAY:

Show error messages and user defined messages. Display source and limit settings.
Show current and voltage measurements View measurements stored in dedicated (6½-digit to 4½-digit). reading buffers.

KEYPAD OPERATIONS:

Change host interface settings.
Save and restore instrument setups.
Load and run factory and user defined test scripts that prompt for input and send results to the display.
Store measurements into dedicated reading buffers.

PROGRAMMING: Embedded Test Script Processor (TSP[®]) scripting engine is accessible from any host interface.

Responds to individual instrument control commands.
Responds to high speed test scripts comprised of instrument control commands and Test Script Language (TSL) statements (for example, branching, looping, and math).
Able to execute high speed test scripts stored in memory without host intervention.

MINIMUM USER MEMORY AVAILABLE: 16MB (approximately 250,000 lines of TSP code).

TEST SCRIPT BUILDER: Integrated development environment for building, running, and managing TSP scripts. Includes an instrument console for communicating with any TSP enabled instrument in an interactive manner. Requires:

VISA (NI-VISA included on CD),
Microsoft[®] .NET Framework (included on CD),
Keithley I/O Layer (included on CD),
Intel[®] Pentium III 800MHz or faster personal computer,
Microsoft Windows[®] 2000, XP, Vista[®], or 7.

TSP EXPRESS (embedded): Tool that allows users to quickly and easily perform common I-V tests without programming or installing software. To run TSP Express, you need:

Java[™] Platform, Standard Edition 6,
Microsoft Internet Explorer[®], Mozilla[®] Firefox[®], or another Java-compatible web browser.

SOFTWARE INTERFACE: TSP Express (embedded), direct GPIB/VISA, read/write with Microsoft Visual Basic[®], Visual C/C++[®], Visual C#[®], LabVIEW[™], CEC TestPoint[™] Data Acquisition Software Package, NI LabWindows[™]/CVI, etc.

READING BUFFERS: Nonvolatile memory uses dedicated storage areas reserved for measurement data. Reading buffers are arrays of measurement elements. Each element can hold the following items:

Measurement	Source setting (at the time the measurement was taken)
Measurement status	Range information
Timestamp	

Two reading buffers are reserved for each Model 2651A channel. Reading buffers can be filled using the front panel STORE key and retrieved using the RECALL key or host interface.

Buffer Size, with timestamp and source setting: >60,000 samples.

Buffer Size, without timestamp and source setting: >140,000 samples.

SYSTEM EXPANSION: The TSP-Link expansion interface allows TSP-enabled instruments to trigger and communicate with each other. See figure below.

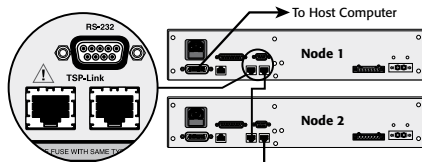

Each Model 2651A has two TSP-Link connectors to make it easier to connect instruments together in sequence.

Once source-measure instruments are interconnected through the TSP-Link expansion interface, a computer can access all the resources of each source-measure instrument through the host interface of any Model 2651A.

A maximum of 32 TSP-Link nodes can be interconnected. Each source-measure instrument consumes one TSP-Link node.

TIMER: Free-running 47-bit counter with 1MHz clock input. Resets each time instrument power is turned on. If the instrument is not turned off, the timer is reset to zero every 4 years.

Timestamp: TIMER value is automatically saved when each measurement is triggered.

Resolution: 1 μ s.

Timestamp Accuracy: \pm 100ppm.

GENERAL

DIGITAL I/O INTERFACE:

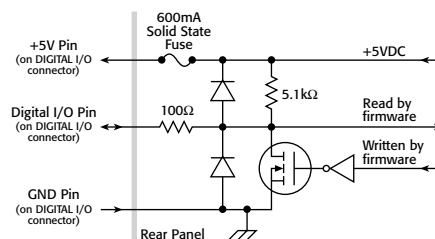

Connector: 25-pin female D.

Input/Output Pins: 14 open drain I/O bits.

Absolute Maximum Input Voltage: 5.25V.

Absolute Minimum Input Voltage: -0.25V.

Maximum Logic Low Input Voltage: 0.7V, +850 μ A max.

Minimum Logic High Input Voltage: 2.1V, +570 μ A.

Maximum Source Current (flowing out of digital I/O bit): +960 μ A.

Maximum Sink Current At Maximum Logic Low Voltage (0.7): -5.0mA.

Absolute Maximum Sink Current (flowing into digital I/O pin): -11mA.

5V Power Supply Pin: Limited to 250mA, solid-state fuse protected.

Output Enable Pin: Active high input pulled down internally to ground with a 10k Ω resistor; when the output enable input function has been activated, the Model 2651A channel will not turn on unless the output enable pin is driven to >2.1V (nominal current = 2.1V/10k Ω = 210 μ A).

IEEE-488: IEEE-488.1 compliant. Supports IEEE-488.2 common commands and status model topology.

RS-232: Baud rates from 300bps to 115200bps. Programmable number of data bits, parity type, and flow control (RTS/CTS hardware or none). When not programmed as the active host interface, the Model 2651A can use the RS-232 interface to control other instrumentation.

ETHERNET: RJ-45 connector, LXI, 10/100BT, Auto MDIX.

LXI COMPLIANCE: LXI Class C 1.2.

Total Output Trigger Response Time: 245 μ s minimum, 280 μ s (typical), (not specified) maximum.

Receive Lan[0-7] Event Delay: Unknown.

Generate Lan[0-7] Event Delay: Unknown.

EXPANSION INTERFACE: The TSP-Link Technology expansion interface allows TSP-enabled instruments to trigger and communicate with each other.

Cable Type: Category 5e or higher LAN crossover cable. 3 meters maximum between each TSP-enabled instrument.

USB: USB 2.0 host controller.

POWER SUPPLY: 100V to 250V AC, 50Hz to 60Hz (autosensing), 550VA maximum.

COOLING: Forced air; side and top intake and rear exhaust.

WARRANTY: 1 year.

EMC: Conforms to European Union EMC Directive.

SAFETY: UL listed to UL61010-1:2004. Conforms to European Union Low Voltage Directive.

DIMENSIONS: 89mm high \times 435mm wide \times 549mm deep (3.5 in. \times 17.1 in. \times 21.6 in.).

BENCH CONFIGURATION (with handle and feet): 104mm high \times 483mm wide \times 620mm deep (4.1 in. \times 19 in. \times 24.4 in.).

WEIGHT: 9.98kg (22 lbs).

ENVIRONMENT: For indoor use only.

ALTITUDE: Maximum 2000 meters above sea level.

OPERATING: 0 $^{\circ}$ to 50 $^{\circ}$ C, 70% relative humidity up to 35 $^{\circ}$ C. Derate 3% relative humidity/ $^{\circ}$ C, 35 $^{\circ}$ to 50 $^{\circ}$ C.

STORAGE: -25 $^{\circ}$ to 65 $^{\circ}$ C.