

Banana Plugs and Jacks

Just need a reliable plug or jack? Making your own test set? Pomona Electronics' selection is designed to meet demanding electrical characteristics. Nickel-plated plugs feature brass bodies and one-piece heat-treated beryllium copper springs with nylon or ABS insulation. Choose Pomona for the reliable and dependable connections your work demands.

Double Banana Plug with Wire Guide, Stackable, Solderless

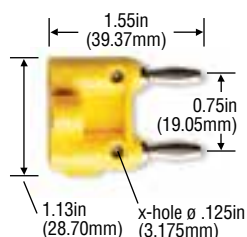

Model#	Plating	Insulation	*Std. Colors
MDP-*	Nickel	Polypropylene	-0 Black, -1 Brown, -2 Red, -3 Orange, -4 Yellow, -5 Green, -6 Blue, -7 Violet, -8 Gray, -9 White
4892-*	Gold	Polypropylene	-0 Black, -2 Red
4898-*	Nickel	Polyphenylene Sulfide	-0 Black, -6 Blue
4914	Set screws 8-32 x 0.210in (5.33mm), 100/pk		

Set screws secure wire. Simplifies cable construction or component mounting. Accepts cables to 0.22in (5.59mm) dia. max., (18-22 AWG wire).

Material: Banana Plug/Jack: brass; Spring: heat treated beryllium copper; Finish: nickel plating.

Rating: For CE compliance and for personal safety, do not hold in hand when voltages exceed 30 Vrms/42.4 Vpk/60 Vdc or current exceeds 8A maximum. Maximum voltage for hands free use: 5000 Vdc. Do not use on circuits where transient stresses can exceed the rated voltage. 15A, +122°F (+50°C) (Model 4898, +302°F (+150°C) max.).

Double Banana Plug with Solder Turret Terminals

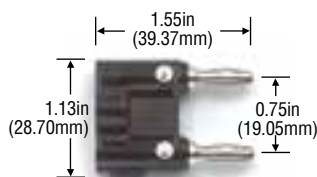

Model# MDP-ST

Similar to MDP above except with bright tin plated solder turrets. Accepts cables to 0.215in (5.46mm) dia. max.

Material: Banana Plug/Jack: brass; Spring: heat treated beryllium copper; Finish: nickel plating; Insulation: polypropylene.

Rating: For CE compliance and for personal safety, do not hold in hand when voltages exceed 30 Vrms/42.4 Vpk/60 Vdc or current exceeds 8A maximum. Maximum voltage for hands free use: 5000 Vdc. Do not use on circuits where transient stresses can exceed the rated voltage. 15A, +131°F (+55°C) max.

Color: Black.

Model# 4914

Set screws 8-32 x 0.210in (5.33mm), 100/pk.

Double Banana Plug with Solder Turret Terminals

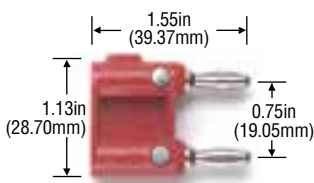

Model# 1330-ST-*

Similar to Model 1330 above, but features bright tin plated solder turrets.

Material: Banana Plug/Jack: brass; Spring: heat treated beryllium copper; Finish: nickel plating; Insulation: polypropylene.

Rating: For CE compliance and for personal safety, do not hold in hand when voltages exceed 30 Vrms/42.4 Vpk/60 Vdc or current exceeds 8A maximum. Maximum voltage for hands free use: 5000 Vdc. Do not use on circuits where transient stresses can exceed the rated voltage. 15A, +122°F (+50°C) max.

*Std. Colors: -0 Black, -2 Red.

Double Banana Plug with Shorting Bar

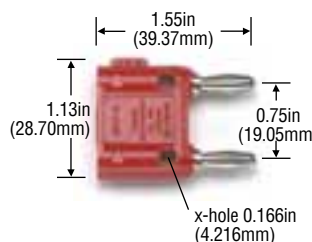

Model# MDP-S-*

Banana plugs internally shorted with #18 AWG wire.

X-hole accepts standard banana plug.

Material: Banana Plug/Jack: brass; Spring: heat treated beryllium copper; Finish: nickel plating; Insulation: Polypropylene.

Rating: For CE compliance and for personal safety, do not hold in hand when voltages exceed 30 Vrms/42.4 Vpk/60 Vdc or current exceeds 8A maximum. Maximum voltage for hands free use: 5000 Vdc. Do not use on circuits where transient stresses can exceed the rated voltage. 15A, +122°F (+50°C) max.

*Std. Colors: -0 Black, -2 Red, -9 White.

Model# 4914

Set screws 8-32 x 0.210in (5.33mm), 100/pk.

Double Banana Plug, Stackable, Solderless

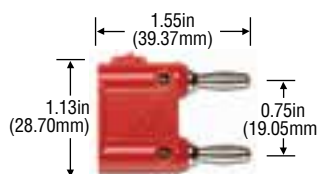

Model# 1330-*

Similar to MDP without cable loop.

Features recess for mounting small components with set screws.

Model 1330 has setscrews like MDP.

Material: Banana Plug/Jack: brass; Spring: heat treated beryllium copper; Finish: nickel plating; Insulation: Polypropylene.

Rating: For CE compliance and for personal safety, do not hold in hand when voltages exceed 30 Vrms/42.4 Vpk/60 Vdc or current exceeds 8A maximum. Maximum voltage for hands free use: 5000 Vdc. Do not use on circuits where transient stresses can exceed the rated voltage. 15A, +122°F (+50°C) max.

*Std. Colors: -0 Black, -2 Red.

Model# 4914

Set screws 8-32 x 0.210in (5.33mm), 100/pk.

Isolated Double Banana Plug with Four Solder Terminals

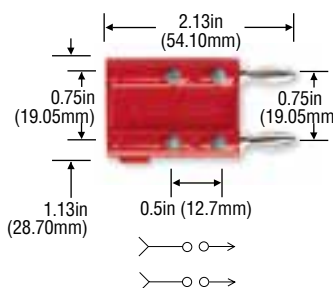

Model# MDP-X

Use to make your own attenuator, balun or filter. Jacks are isolated from plugs.

Material: Banana Plug/Jack: brass; Spring: heat treated beryllium copper; Finish: nickel plating; Insulation: Polypropylene; Solder turrets; bright tin plated.

Rating: For CE compliance and for personal safety, do not hold in hand when voltages exceed 30 Vrms/42.4 Vpk/60 Vdc or current exceeds 8A maximum. Maximum voltage for hands free use: 2500 Vdc. Do not use on circuits where transient stresses can exceed the rated voltage. 15A, +131°F (+55°C) max.

Color: Red.

*Color Code: -0 Black, -1 Brown, -2 Red, -3 Orange, -4 Yellow, -5 Green, -6 Blue, -7 Violet, -8 Gray, -9 White

Isolated Double Banana Plug with Three Solder Terminals

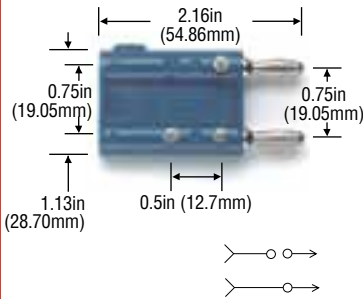

Model# 1837

Use to make your own attenuator, balun or filter.

One jack is isolated.

Material: Banana Plug/Jack: brass; Spring: heat treated beryllium copper; Finish: nickel plating; Insulation: polypropylene; Solder turrets: bright tin plated.

Rating: For CE compliance and for personal safety, do not hold in hand when voltages exceed 30 Vrms/42.4 Vpk/60 Vdc or current exceeds 8A maximum. Maximum voltage for hands free use: 2500 Vdc. Do not use on circuits where transient stresses can exceed the rated voltage. 15A, +131°F (+55°C) max.

Color: Blue.

Isolated Single Banana Plug with Two Solder Terminals

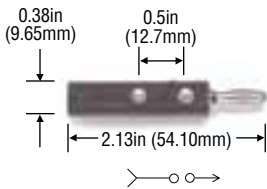

Model# 1390-*

Ideal for computers, lab circuit design and testing.

Jack is isolated from plug.

Material: Banana Plug/Jack: brass; Spring: heat treated beryllium copper; Finish: nickel plating; Insulation: polypropylene; Solder turrets: bright tin plated.

Rating: For CE compliance and for personal safety, do not hold in hand when voltages exceed 30 Vrms/42.4 Vpk/60 Vdc or current exceeds 8A maximum. Maximum voltage for hands free use: 2500 Vdc. Do not use on circuits where transient stresses can exceed the rated voltage. 15A, +131°F (+55°C) max.

***Std. Colors:** -0 Black, -2 Red.

QUAD Stacking Plug

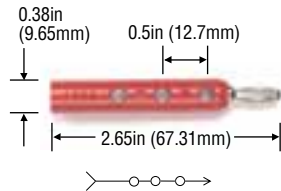

Model# 3364-*

Features one in-line stacking and three cross-stacking connections.

All jacks are connected to plug.

Material: Banana Plug/Jack: brass; Spring: heat treated beryllium copper; Finish: nickel plating; Insulation: ABS.

Rating: For CE compliance and for personal safety, do not hold in hand when voltages exceed 30 Vrms/42.4 Vpk/60 Vdc or current exceeds 8A maximum. Maximum voltage for hands free use: 5000 Vdc. Do not use on circuits where transient stresses can exceed the rated voltage. 15A, +122°F (+50°C) Max.

***Std. Colors:** -0 Black, -2 Red.

Triple Banana Plug, Stackable, Solderless

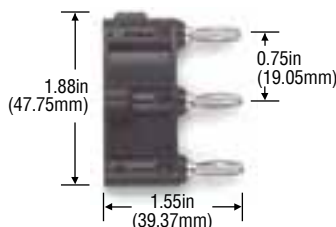

Model# 2970-*

Use for balanced line 2 conductor shielded cable assemblies. Accepts cables to 0.250in (6.35mm) dia. max., Setscrews secure wires.

Material: Banana Plug/Jack: brass; Spring: heat treated beryllium copper; Finish: nickel plating; Insulation: Polypropylene.

Rating: For CE compliance and for personal safety, do not hold in hand when voltages exceed 30 Vrms/42.4 Vpk/60 Vdc or current exceeds 8A maximum. Maximum voltage for hands free use: 5000 Vdc. Do not use on circuits where transient stresses can exceed the rated voltage. 15A, +122°F (+50°C) max.

***Std. Colors:** -0 Black, -2 Red.

4mm Safety Banana Jack to Banana Plug Adapter



Model# 6728

Accepts safety-sheathed 4mm banana plug and adapts to standard banana plug.

Material: nickel plated brass.

Rating: For CE compliance and for personal safety, do not hold in hand when voltages exceed 30 Vrms/42.4 Vpk/60 Vdc or current exceeds 8A maximum, -10 to +55°C.

***Std. Colors:** -0 Black, -2 Red.

Double Banana Plug Splice

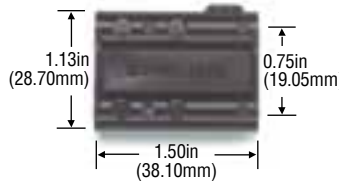

Model# 1823-*

Provides rapid method for splicing cables.

Rating: For CE compliance and for personal safety, do not hold in hand when voltages exceed 30 Vrms/42.4 Vpk/60 Vdc or current exceeds 8A maximum. Maximum voltage for hands free use: 5000 Vdc. Do not use on circuits where transient stresses can exceed the rated voltage. 15A, +131°F (+55°C) max.

***Std. Colors:** -0 Black, -2 Red.

Single Banana Plug Splice

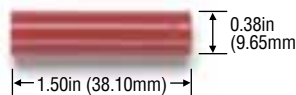

Model# 1829-*

Provides rapid method for splicing single banana plug patch cords.

Rating: For CE compliance and for personal safety, do not hold in hand when voltages exceed 30 Vrms/42.4 Vpk/60 Vdc or current exceeds 8A maximum. Maximum voltage for hands free use: 5000 Vdc. Do not use on circuits where transient stresses can exceed the rated voltage. 15A, +55°C (+131°F) max.

***Std. Colors:** -0 Black, -2 Red.

Insulated Double Banana Plug Shorting Bar

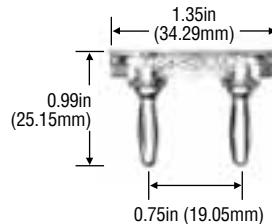

Model# 5145

Shorting bar is completely insulated in clear ABS thermoplastic.

Fits standard 0.166in (4.22mm) dia. banana jack.

Material: Banana Plug Body: brass; Spring: beryllium copper; Finish: nickel plating.

Rating: 15A, +122°F (+50°C) max., resistance less than 1.5mΩ.

Do-It-Yourself 4mm Stackable Banana Plug, Solder

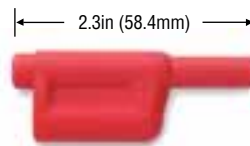

Model# 6721

Build your own safety stacking leads with do-it-yourself safety-sheathed 4mm stackable banana plugs.

Material: Contacts: nickel-plated brass, Insulation: lucel acetal polymer.

Rating: IEC61010 1000V Category III**, 20A, 14 to 176°F (-10 to +95°C).

***Std. Colors:** -0 Black, -2 Red.

** When plug is correctly assembled and terminated.

Do-It-Yourself In-Line Sheathed (4mm) Banana Plug and Jack

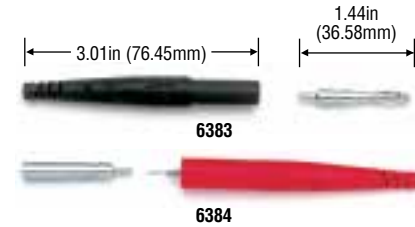

Safety-rated plugs and jacks for use with any wire from 22 to 18 AWG with flexible insulation. Attaches to wire by crimp or soldering.

Plugs fit most sheathed DMM jacks and DMM test leads to make up your own banana plug or jack test lead or jumper.

See mating panel jacks (6387 on page 37).

Material: Banana Plug/Jack: brass; Spring: heat treated beryllium copper; Insulation: Santoprene®.

Rating: CAT II 300V, 15A, +275°F (+135°C) max.

***Std. Colors:** -0 Black, -2 Red, -02 Black and Red (2 per pkg).

*Sold in pkgs of 10.

Model#	Type
6383-*	Plug
6383-02	
6384-*	Jack
6384-02	

Do-It-Yourself Solderless Stackup Banana Plug with Safety Shield

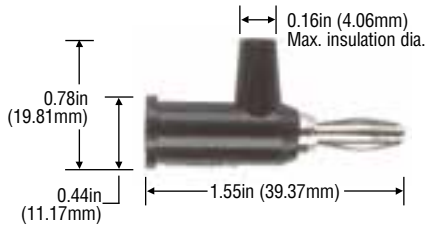

Internal set screw holds wire firmly.

Safety collar insulates exposed wire leads.

Accepts standard banana plug and fits 0.166in (4.22mm) dia. banana jack.

Material: Banana Plug/Jack: brass; Spring: heat treated beryllium copper.

Rating: For CE compliance and for personal safety, do not hold in hand when voltages exceed 30 Vrms/42.4 Vpk/60 Vdc or current exceeds 8A maximum. Maximum voltage for hands free use: 5000 Vdc. Do not use on circuits where transient stresses can exceed the rated voltage. 15A, +122°F (+50°C) max. (Model 4899, +302°F (+150°C) max.).

Accepts 18-22 AWG wire.

Model#	Plating	Insulation	Std. Colors
1825-*	Nickel	Polypropylene	-0 Black, -1 Brown, -2 Red, -3 Orange, -4 Yellow, -5 Green, -6 Blue, -7 Violet, -8 Gray, -9 White. Sold in pkgs of 10
4897	Gold	Polypropylene	-0 Black, -2 Red
4899	Nickel	Polyphenylene Sulfide	-0 Black, -6 Blue Sold in pkgs of 10
6545	Nickel	Polypropylene	Pkg of 1 ea. of all 10 colors

Do-It-Yourself Solderless Stackup Banana Plug

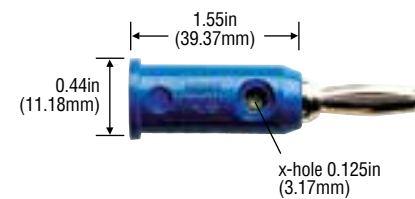

4914 set screws 8-32 x 0.210 (5.33mm), 100/pk.

Internal set screw holds wire firmly.

Accepts standard banana plug, fits standard 0.166in (4.22mm) dia. banana jack.

Material: Banana Plug/Jack: brass; Spring: heat treated beryllium copper.

Rating: For CE compliance and for personal safety, do not hold in hand when voltages exceed 30 Vrms/42.4 Vpk/60 Vdc or current exceeds 8A maximum. Maximum voltage for hands free use: 5000 Vdc. Do not use on circuits where transient stresses can exceed the rated voltage. 15A, +122°F (+50°C) max. (Model 5230, +302°F (+150°C) max.).

Accepts 18-22 AWG wire.

Model#	Plating	Insulation	Std. Colors
1325-*	Nickel	Polypropylene	-0 Black, -1 Brown, -2 Red, -3 Orange, -4 Yellow, -5 Green, -6 Blue, -7 Violet, -8 Gray, -9 White.
5406	Gold	Polypropylene	-0 Black, -2 Red
5230	Nickel	Polyphenylene Sulfide	-0 Black, -6 Blue
6546	Nickel	Polypropylene	Pkg of 1 ea. of all 10 colors

*Sold in pkgs of 10.

Do-It-Yourself 4mm Right Angle Banana Plug



Model# 6729

Build your own safety leads with do-it-yourself safety-sheathed 4mm right angle banana plug.

Material: Contacts: nickel-plated brass; Insulation: lucel acetal polymer.

Rating: IEC61010 1000V Category III**, 20A, 14 to 176°F (-10 to +55°C).

***Std. Colors:** -0 Black, -2 red.

** When plug is correctly assembled and terminated.

Do-It-Yourself In-Line Sheathed Banana Plug/Banana Jack

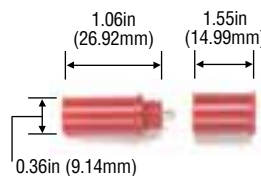

4933/4986 Plugs



4934 Jacks

Model#	Accepts wire AWG	Wire Access Hole	Type
4933-*	22, 20, 18	0.159in (4.04mm) Dia.	Plug
4986-*	16, 14	0.200in (50.8mm) Dia.	Plug
4934-*	22, 20, 18	0.159in (4.04mm) Dia.	Jack

These plugs and jacks are designed to fit together and provide protection from accidental shorting.

Material: Banana Plug/Jack: brass; Spring: beryllium copper; Insulation: polypropylene.

Rating: For CE compliance and for personal safety, do not hold in hand when voltages exceed 30 Vrms/42.4 Vpk/60 Vdc or current exceeds 8A maximum. Maximum voltage for hands free use: 1200V ac/dc. Do not use on circuits where transient stresses can exceed the rated voltage. 15A, +176°F (+80°C) max.

***Std. Colors:** -0 Black, -2 Red.

Do-It-Yourself Retractable Sheath Banana Plug

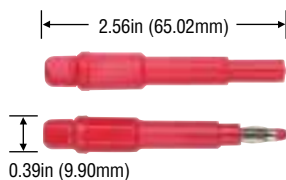

Model#	Color
122505A	Black
122506A	Red

Do-It-Yourself Retractable Sheath Banana Plugs provide fast simple assembly and reliable performance.

Rating: For CE CAT II 300V, CAT III 150V. Maximum voltage for hands free use: 1000 Vrms, 20A, ≤ 2 mΩ.

Accepts 18-22 AWG wire.

*Color Code: -0 Black, -1 Brown, -2 Red, -3 Orange, -4 Yellow, -5 Green, -6 Blue, -7 Violet, -8 Gray, -9 White

Rivet Type Banana Plug

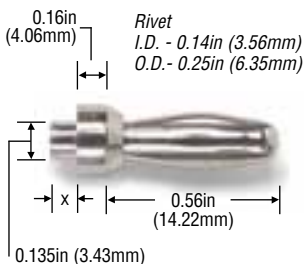

Model#	"X"	Panel
3257	0.094in (2.39mm)	0.062in (1.57mm)
3258	0.125 (3.17mm)	0.093in (2.36mm)

Excellent for riveting to panels or boards. Fits standard 0.166in (4.22mm) dia. banana jack.
Material: *Banana Plug Body:* brass; *Spring:* beryllium copper; *Finish:* nickel plating.
Rating: For CE compliance and for personal safety, do not hold in hand when voltages exceed 30 Vrms/42.4 Vpk/60 Vdc or current exceeds 8A maximum. Maximum voltage for *hands free use:* 5000 Vdc. Do not use on circuits where transient stresses can exceed the rated voltage. 15A.
 Sold in pkgs. of 10.

Rivet Type Banana Plug with Turret

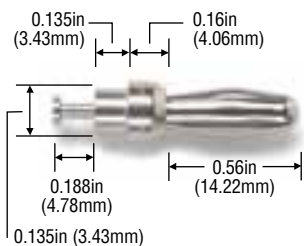

Model# 3261
 Excellent for riveting to panels or boards. Solder turret for rapid attachment of wires. Fits standard 0.166in (4.22mm) dia. banana jack.
Material: *Banana Plug Body:* brass; *Spring:* beryllium copper; *Finish:* nickel plating.
Rating: For CE compliance and for personal safety, do not hold in hand when voltages exceed 30 Vrms/42.4 Vpk/60 Vdc or current exceeds 8A maximum. Maximum voltage for *hands free use:* 5000 Vdc. Do not use on circuits where transient stresses can exceed the rated voltage. 15A.
 Sold in pkgs. of 10.

Banana Plug with Threaded Stud and Solder Lug

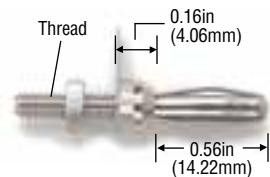

Model#	Thread
3263	6-32 x .50in (12.70mm)
3264	8-32 x .50in (12.70mm)
4512	8-32 x .63in (16.00mm)

Fits standard 0.166in (4.22mm) dia. banana jack.
Material: *Banana Plug Body:* brass; *Spring:* beryllium copper; *Finish:* nickel plating.
Rating: For CE compliance and for personal safety, do not hold in hand when voltages exceed 30 Vrms/42.4 Vpk/60 Vdc or current exceeds 8A maximum. Maximum voltage for *hands free use:* 5000 Vdc. Do not use on circuits where transient stresses can exceed the rated voltage. 15A.
 Sold unassembled, in pkgs. of 10.

Insulated Banana Plug and Jack with Flexible Boot, Solder or Crimp

Model#	Accepts wire AWG	Type	Mates with...
5169-*	22, 20, 18	Plug	Jack 5167
5170-*	16, 14		Jack 5168
5167-*	22, 20, 18	Jack	Plug 5169
5168-*	16, 14		Plug 5170



5169/5170 Boots



5167/5168 Jacks

Ideal for making patch cords or field repairs. Snap-on flexible PVC boot allows wire to be crimped or soldered to banana plug or jack. Fits standard 0.166in (4.22mm) dia. banana jack.
Material: *Boot:* Banana Plug Body: brass; *Spring:* beryllium copper; *Finish:* nickel plating; *Jack:* nickel plated brass.
Rating: For CE compliance and for personal safety, do not hold in hand when voltages exceed 30 Vrms/42.4 Vpk/60 Vdc or current exceeds 8A maximum. Maximum voltage for *hands free use:* 5000 Vdc. Do not use on circuits where transient stresses can exceed the rated voltage. 15A, +122°F (+50°C.) max.
 *Std. Colors: -0 Black, -2 Red.

Banana Plug with Screw and Soldering Lug



Model#	Thread
3265	6-32 x 0.25in (6.35mm)
3266	8-32 x 0.25in (6.35mm)

Fits standard 0.166in (4.22mm) dia. banana jack.
Material: *Banana Plug Body:* brass; *Spring:* beryllium copper; *Finish:* nickel plating.
Rating: For CE compliance and for personal safety, do not hold in hand when voltages exceed 30 Vrms/42.4 Vpk/60 Vdc or current exceeds 8A maximum. Maximum voltage for *hands free use:* 5000 Vdc. Do not use on circuits where transient stresses can exceed the rated voltage. 15A.
 Sold unassembled, in pkgs. of 10.

4mm Banana Plug with Threaded M3 Stud



Model# 72918
 4mm plug with threaded M3 stud, 2 nuts; 12mm (0.5in) stud length.
 Sold unassembled, in pkgs. of 10.
Rating: For CE compliance and for personal safety, do not hold in hand when voltages exceed 30 Vrms/42.4 Vpk/60 Vdc or current exceeds 8A maximum. Maximum voltage for *hands free use:* 5000 Vdc. Do not use on circuits where transient stresses can exceed the rated voltage. 36A.

Panel Mount IEC61010 Banana Jacks for Sheathed Plugs



Model#	Color	Terminal
72912-0	Black	Threaded Stud
72912-2	Red	-
72913-0	Black	Solder Tab
72913-2	Red	-
72930*	-	Threaded Stud, Hexagonal Nut

Material: Gold-plated nickel (72912 and 72913).
Rating: 1000V Cat III, 36A Max.
 *Std. Colors: all except -3 orange, see below
 Sold in packages of 10 per color.

Panel Mount IEC61010 4 mm (0.16in) Banana Jack for Sheathed Plugs

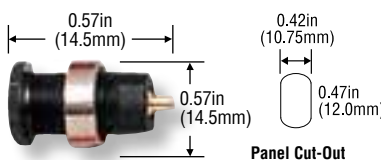

Model# 5931-*
 Accepts flexible test lead sets 5907A, 5908A, 5909A available on page 68.
Max. Panel Thickness: 0.28in (7.0mm).
Insulation: Nylon.
Rating: 1000 V Cat III per IEC61010-031 and IEC61010-1, 25A.
 *Std. Colors: -0 Black, -2 Red, -5 Green, -6 Blue, -9 White.
 Sold in pkgs. of 10 per color.

Terminal Strip Adapter, 4mm Safety Banana Jack to 6/32



Model# 6720
 Easily connect your DMM safety sheathed test leads to terminal strips via this handy 6/32 thread adapter.
Material: *Contacts:* nickel-plated brass, *Insulation:* lucel acetal polymer.
Rating: For CE compliance and for personal safety, do not hold in hand when voltages exceed 30 Vrms/42.4 Vpk/60 Vdc or current exceeds 8A maximum. (14 to 212°F) -10 to +55°C.
 *Std. Colors: -0 Black, -2 Red.

Panel Mount Banana Jacks with Mounting Base

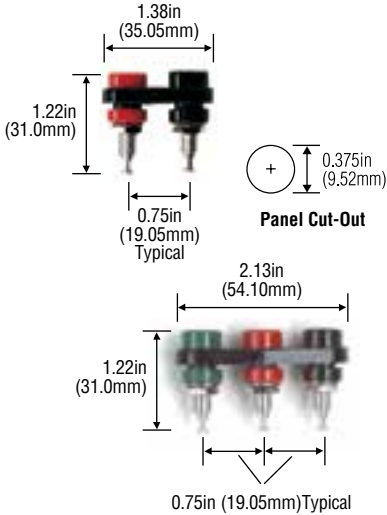

Model#	Mounting Base
2269-*	Double
5233-0	Double High-Temp
4601-*	Triple

Mounts in panels from 0.063in (1.60mm) to 0.375in (9.53mm) thick. One black, one red. Triple has green.

Rating: For CE compliance and for personal safety, do not hold in hand when voltages exceed 30 Vrms/42.4 Vpk/60 Vdc or current exceeds 8A maximum. Maximum voltage for *hands free use*: 2500 Vdc. Do not use on circuits where transient stresses can exceed the rated voltage. 15A.

Temp: +239F (+115°C) [5233-0: +220°F (+428°C)].

***Mounting base color:** -0 Black, -2 Red.

Replacement hex nuts available on page 39.

Panel Mount Banana Jacks for Sheathed Plugs

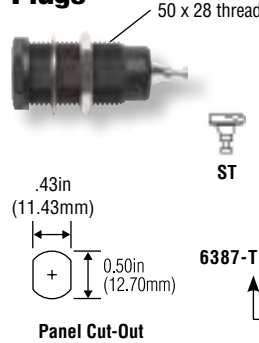

Model#	Std. Colors
6387-ST-T-*	-0 Black, -2 Red

These banana jacks fit most DMM plugs and all sheathed Pomona plugs. Available with several different terminals. Threaded and press-in style.

Rating: Designed to meet IEC61010 CAT III 1000 Vrms., 15A.

Sold in packages of 10.

Comes with Hex Nut and Lock Washer.

Replacement hex nuts available on page 39.

Color Options: -0 Black, -2 Red.

Plating Option: T=Tin

Terminal Type: ST=Solder Turret

Uninsulated Banana Jack

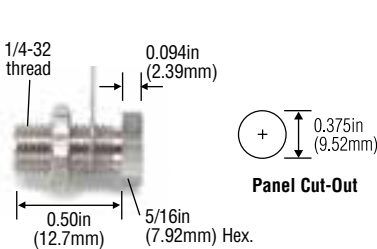

Model# 3267

Fits standard banana plug.

Material: nickel-plated brass.

Rating: For CE compliance and for personal safety, do not hold in hand when voltages exceed 30 Vrms/42.4 Vpk/60 Vdc or current exceeds 8A maximum. Maximum voltage for *hands free use*: 5000 Vdc. Do not use on circuits where transient stresses can exceed the rated voltage. 15A.

Replacement hex nuts available on page 39.

Banana Jack with Wire Wrap Terminal

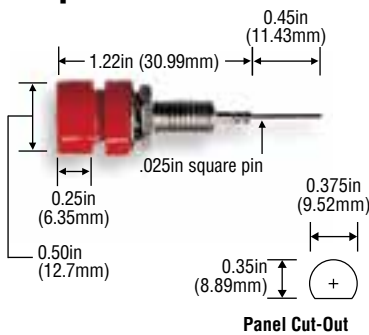

Model# 4005-*

Material: Jack: nickel-plated brass; Terminal: gold-plated phosphor bronze; Insulation: polycarbonate.

Rating: For CE compliance and for personal safety, do not hold in hand when voltages exceed 30 Vrms/42.4 Vpk/60 Vdc or current exceeds 8A maximum. Maximum voltage for *hands free use*: 2500 Vdc. Do not use on circuits where transient stresses can exceed the rated voltage. 3A, +239°F (+115°C) max.

***Std. Colors:** -0 Black, -2 Red.

Sold in pkgs. of 10 per color.

Replacement hex nuts available on page 39.

Panel Mount Banana Jack

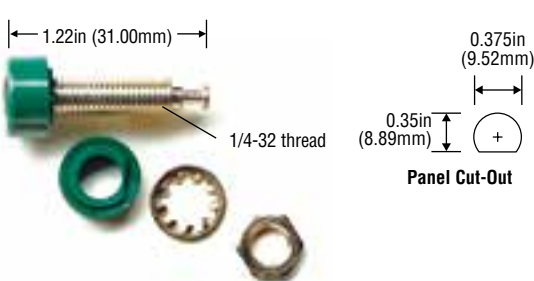

Model#	Plating	Insulation	Std. Colors
1581-*	Bright tin	Polycarbonate	-0 Black, -1 Brown, -2 Red, -3 Orange, -4 Yellow, -5 Green, -6 Blue, -7 Violet, -8 Gray, -9 White
2854-*	Gold	Polycarbonate	-0 Black, -1 Brown, -2 Red, -4 Yellow, -5 Green, -6 Blue, -8 Gray, -9 White
4900-*	Bright tin	Polyphenylene Sulfide	-0 Black, -6 Blue

Mounts in panels ranging in thickness from 0.063in (1.60mm) to 0.375in (9.53mm).

Material: Brass.

Rating: For CE compliance and for personal safety, do not hold in hand when voltages exceed 30 Vrms/42.4 Vpk/60 Vdc or current exceeds 8A maximum.

Maximum voltage for *hands free use*: 2500 Vdc. Do not use on circuits where transient stresses can exceed the rated voltage. 15A, +239°F (+115°C) max. (Model 4900, +428°F (+220°C) max.).

Mounting Bases and replacement hex nuts available on page 38-39.

Sold in pkgs. of 10 per color.

Terminal Strip Banana Jack Adapter

Model#	Thread	Vrms	Torque In/Lb	X Stud Length
5699-*	6-32	1100	7	0.25in (6.35mm)
5700-*	8-32	1600	16	0.32in (8.13mm)
5701-*	10-32	1700	25	0.32in (8.13mm)

This adapter provides a banana jack connection by replacing the screw in a terminal strip. Secure connections can be made with standard banana plug patch cords without breaking the connection to the terminal strip. Banana jack 0.166in (4.22mm) dia.

Material: Banana Jack: nickel-plated brass; Insulation: Nylon.

***Std. Colors:** -0 Black, -2 Red, -3 Orange, -4 Yellow, -9 White.

Rating: For CE compliance and for personal safety, do not hold in hand when voltages exceed 30 Vrms/42.4 Vpk/60 Vdc or current exceeds 8A maximum. Maximum voltage for *hands free use*: (see chart for Vrms for each model#). Do not use on circuits where transient stresses can exceed the rated voltage. 25A, +216°F (+102°C) max.

Terminal Strip Banana Jack Adapter

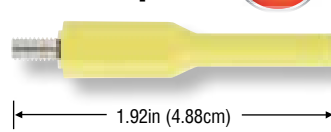

Model#	Thread	Torque In/Lb	Length
73084-*	6-32 male	7	1.92in (4.88cm)
73085-*	10-32 male	20	1.92in (4.88cm)
73086-*	10-32 female	20	1.54in (3.91cm)
73088-*	8-32 male	16	1.92in (4.88cm)

Easily connect safety sheathed banana plug test leads to terminal strips via this Terminal Strip Banana Jack Adapter.

Material: Contacts: nickel-plated brass, Insulation: polypropylene.

***Std. Colors:** -0 Black, -2 Red, -4 Yellow, -6 Blue.

Rating: For CE Compliance and for personal safety, do not hold in hand when voltages exceed 30 Vrms/42.4 Vpk/60 Vdc or current exceeds 8A maximum. Maximum voltage for *hands free use*: 600 Vrms. Do not use on circuits where transient stresses can exceed the rated voltage. 20A, -10° C to +80° C (+14° F to 176° F).

*Color Code: -0 Black, -1 Brown, -2 Red, -3 Orange, -4 Yellow, -5 Green, -6 Blue, -7 Violet, -8 Gray, -9 White

Binding Posts

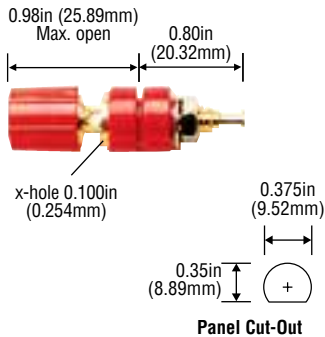

Panel Cut-Out

Model#	Material
3750-*	Gold-plated brass
3760-*	Bright tin-plated brass
3770-*	Gold-plated tellurium copper

Insulation: Polycarbonate.

Rating: For CE compliance and for personal safety, do not hold in hand when voltages exceed 30 Vrms/42.4 Vpk/60 Vdc or current exceeds 8A maximum. Maximum voltage for *hands free use*: 2500 Vdc. Do not use on circuits where transient stresses can exceed the rated voltage. 15A, +239°F (+115°C) max.

*Std. Colors: 3750 and 3760: all 10 colors. 3770: -0 Black, -2 Red.

Sold unassembled.

Hex Head Binding Post

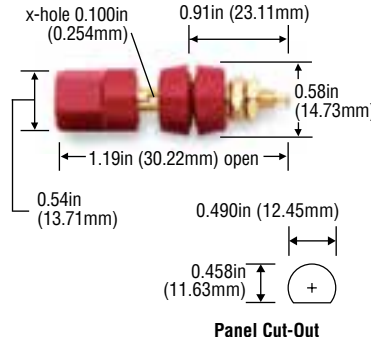

Panel Cut-Out

Model# 5018-*

Meets MIL-P-55149/1A.

Material: Binding Post Body, Nuts, Lockwasher: gold-plated brass; Insulation: Nylon MIL-P-20693.

Rating: For CE compliance and for personal safety, do not hold in hand when voltages exceed 30 Vrms/42.4 Vpk/60 Vdc or current exceeds 8A maximum. Maximum voltage for *hands free use*: 1500 Vrms. Do not use on circuits where transient stresses can exceed the rated voltage. 30A, +176° (+80°C) max.

*Std. Colors: -0 Black, -2 Red, -4 Yellow, -5 Green, -6 Blue, -9 White.

Binding Post with Double Mounting

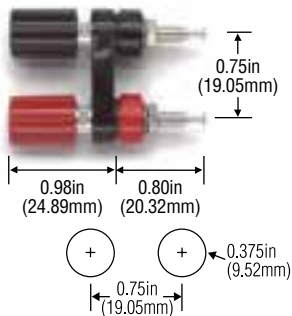

Panel Cut-Out

Model# 4243-*

Accepts standard banana plugs and 0.080in (2.03mm) pin tips, wires and probe tips in 0.10in (2.54mm) cross-hole.

One black and one red binding post.

Material: Binding Post: bright tin-plated brass; Insulation: polycarbonate.

Rating: For CE compliance and for personal safety, do not hold in hand when voltages exceed 30 Vrms/42.4 Vpk/60 Vdc or current exceeds 8A maximum. Maximum voltage for *hands free use*: 2500 Vdc. Do not use on circuits where transient stresses can exceed the rated voltage. 15A, +239°F (+115°C) max.

*Mtg. Base Colors: -0 Black, -2 Red.

Spring Loaded Binding Post

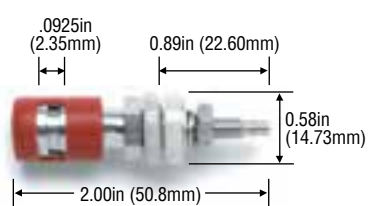

Model# 4995-*

Meets MIL-P-55149/8.

Silicone rubber O-rings provide water resistant seal when mounted in panels from 0.062in to 0.125in (15.75mm to 3.18mm) thick.

Material: Nickel-plated brass.

*Std. Colors: -0 Black, -2 Red.

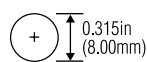

Panel Cut-Out

Dual Binding Posts

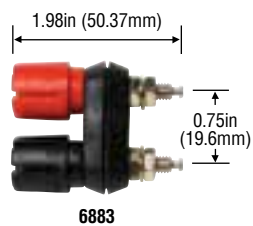

6883

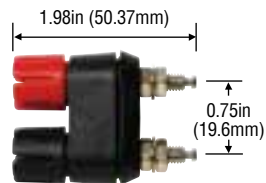

6884

Model#	Base
6883	Standard
6884	Raised Base

5-way binding post with 3.91 mm (0.154 in) cross-hole that accepts up to 12 AWG wire and standard banana plugs. Posts are spaced at the standard 3/4 inch spacing to mate to dual banana plugs.

Material: Binding Post: nickel-plated brass. Insulators: nylon.

Rating: 30A current.

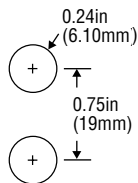

Panel Cut-Out for 6883/6884

Spring Loaded Binding Post

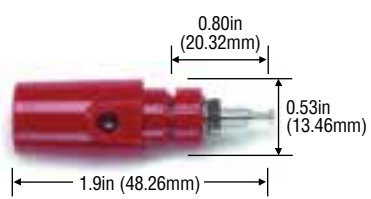

Model# 4770-*

Mounts in panels from 0.06in (1.6mm) to 0.38in (9.53mm) thick.

Accepts wires or plugs up to 0.08in (2.16mm) dia. with insulation up to 0.16in (4.06mm).

Material: Body: tin plated brass; Insulation: polycarbonate.

Rating: For CE compliance and for personal safety, do not hold in hand when voltages exceed 30 Vrms/42.4 Vpk/60 Vdc or current exceeds 8A maximum. Maximum voltage for *hands free use*: 630 Vdc. Do not use on circuits where transient stresses can exceed the rated voltage. 15A, +239°F (+115°C) max.

*Std. Colors: -0 Black, -2 Red.

Binding Post/Banana Jack Mounting Bases

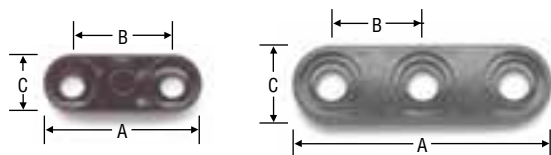

For binding post models 3750, 3760, 3770

Model#	Type	Used with	A	B	C
3862-*	Double	Standard	1.19in (30.22mm)	0.75in (19.05mm)	0.44in (11.18mm)
3863-*	Triple	Binding Posts	1.94in (49.28mm)	0.75in (19.05mm)	0.44in (11.18mm)
4619-*	Double	Miniature	0.87in (22.09mm)	0.50in (12.70mm)	0.38in (9.65mm)
4614-*	Triple	Banana Jacks	1.38in (35.05mm)	0.50in (12.70mm)	0.38in (9.65mm)
4654-*	Double	Standard	1.38in (35.05mm)	0.75in (19.05mm)	0.63in (16.00mm)
4590-*	Triple	Banana Jacks	2.13in (54.10mm)	0.75in (19.05mm)	0.63in (16.00mm)

Mount banana jacks and binding posts at standard 0.75in (19.05mm) spacing.

Material: polycarbonate

Rating: +239°F (+115°C) Max.

*Std. Colors: -0 Black.

Sold in pkgs. of 10.

Shorting Link for Standard Binding Posts

Model# 4115

Solid shorting link for binding posts.
Material: nickel-plated brass.
Rating: 15A.
Sold in pkgs. of 10.
Fits Binding Posts on 0.750in (19.05mm) centers.

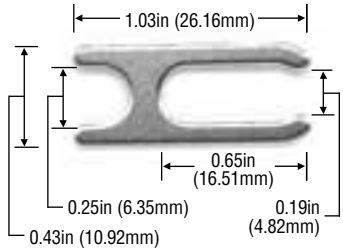

Miniature Double Banana Plug with Set Screws, Stackable, Solderless

Model# 2244-*

Internal set screws secure cable up to 0.15in (3.81mm) dia. or components.
Plugs fit miniature 0.104in (2.64mm) dia. jacks.

Material: Banana Plug/Jack: brass; Spring: beryllium copper; Finish: gold plating; Insulation: ABS

Rating: For CE compliance and for personal safety, do not hold in hand when voltages exceed 30 Vrms/42.4 Vpk/60 Vdc or current exceeds 8A maximum. Maximum voltage for hands free use: 2500 Vdc. Do not use on circuits where transient stresses can exceed the rated voltage. 5A, +122°F (+50°C) max.

*Std. Colors: -0 Black, -2 Red.

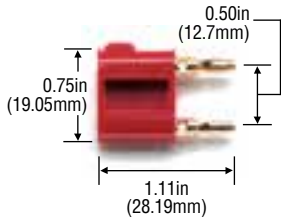

Miniature Solderless Type Triple Banana Plug with Wire Guide

Model# 4653-0

Use for balanced line 2 conductor shielded cable assemblies.

Material: Banana Plug/Jack: brass; Spring: beryllium copper; Finish: gold plating; Insulation: ABS.

Rating: For CE compliance and for personal safety, do not hold in hand when voltages exceed 30 Vrms/42.4 Vpk/60 Vdc or current exceeds 8A maximum. Maximum voltage for hands free use: 2500 Vdc. Do not use on circuits where transient stresses can exceed the rated voltage. 5A, +122°F (+50°C) max.

Cable strain relief I.D. 0.19in (4.82mm).
Setscrews secure wires.

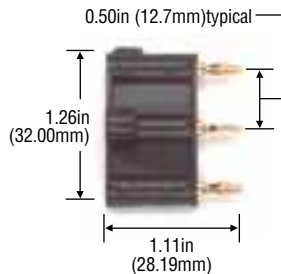

Replacement Hex Nuts

Model#	Qty.	Finish	Wrench Size	Nut Thickness	Thread
6549	500	Nickel	3/16in	0.65in (16.51mm)	4-40
6547	500	Nickel	1/4in	0.95in (24.13mm)	6-32
6440	500	Nickel	1/4in	0.95in (24.13mm)	8-32
6548	100	Gold	3/8in	0.95in (24.13mm)	10-32
6441	500	Nickel	3/8in	0.95in (24.13mm)	1/4-32
6389	100	Nickel	9/16in	0.95in (24.13mm)	1/2-28

Hex Nut	6549	6547	6440	6548	6441	6389
Fits on	3276 4513	3263 4511 6271	2142 2143 2382 2383 2439 2440 3264 3542 3750 3760	3770 4022 4098 4243 4512 4543 4773 6272	5018	1581 2269 2854 3267 4005 4069 4601 4900 5233 6270

*Color Code: -0 Black, -1 Brown, -2 Red, -3 Orange, -4 Yellow, -5 Green, -6 Blue, -7 Violet, -8 Gray, -9 White

Miniature Solder Type Banana Plug

Model#	Insulator Length (X)
3690-*	0.45in (11.43mm)
4617-*	1.00in (25.14mm)

Sold in pkgs. of 10

Material: Banana Plug Body: brass; Spring: beryllium copper; Finish: gold plating; Insulation: nylon.

Rating: For CE compliance and for personal safety, do not hold in hand when voltages exceed 30 Vrms/42.4 Vpk/60 Vdc or current exceeds 8A maximum. Maximum voltage for hands free use: 2500 Vdc. Do not use on circuits where transient stresses can exceed the rated voltage. 5A, +176°F (+80°C) max.

*Std. Colors: -0 Black, -2 Red.

Fits miniature 0.104in (2.64mm) dia. banana jacks.

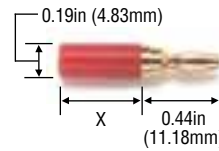

Miniature Banana Plug with Threaded Stud

Model#	X Length
3276	0.230in (5.84mm)
4513	0.480in (12.19mm)

Fits miniature 0.104in (2.64mm) dia. banana jacks.

Furnished with 4-40 hex nut, 4-40 threaded stud.

Material: Banana Plug Body: brass; Spring: beryllium copper; Finish: gold plating.

Rating: For CE compliance and for personal safety, do not hold in hand when voltages exceed 30 Vrms/42.4 Vpk/60 Vdc or current exceeds 8A maximum. Maximum voltage for hands free use: 2500 Vdc. Do not use on circuits where transient stresses can exceed the rated voltage. 5A.

Replacement hex nut available on page 39.

Sold unassembled, in pkgs. of 10.

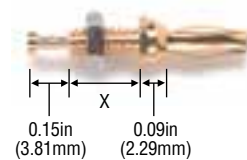

Do-It-Yourself Miniature Banana Plug, Stackable, Solderless

Model# 2944-*

Fits miniature 0.104in (2.64mm) dia. banana jacks.

Wire firmly held in place with internal set screw.

Material: Banana Plug/Jack: brass; Spring: beryllium copper; Finish: gold plating; Insulation: ABS.

Rating: For CE compliance and for personal safety, do not hold in hand when voltages exceed 30 Vrms/42.4 Vpk/60 Vdc or current exceeds 8A maximum. Maximum voltage for hands free use: 2500 Vdc. Do not use on circuits where transient stresses can exceed the rated voltage. 5A, +122°F (+50°C) max.

*Std. Colors: -0 Black, -2 Red.

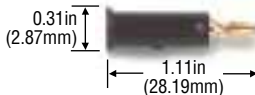

Do-It-Yourself Miniature Banana Plug with Safety Shield, Stackable, Solderless

Model# 2945-*

Fits miniature 0.104in (2.64mm) dia. banana jacks.

Wire firmly held in place with internal set screw.

Material: Banana Plug/Jack: brass; Spring: beryllium copper; Finish: gold plating; Insulation: ABS

Rating: For CE compliance and for personal safety, do not hold in hand when voltages exceed 30 Vrms/42.4 Vpk/60 Vdc or current exceeds 8A maximum. Maximum voltage for hands free use: 2500 Vdc. Do not use on circuits where transient stresses can exceed the rated voltage. 5A, +122°F (+50°C) max.

*Std. Colors: -0 Black, -2 Red.

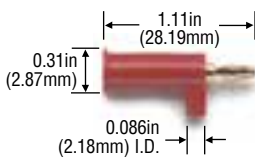

Miniature Double Banana Plug with Shorting Bar

Model# 2035-*

Plugs fit miniature 0.104in (2.64mm) dia. banana jacks.

Banana plugs internally shorted with 18 AWG wire.

Material: Banana Plug/Jack: brass; Spring: beryllium copper; Finish: gold plating; Insulation: ABS.

Rating: For CE compliance and for personal safety, do not hold in hand when voltages exceed 30 Vrms/42.4 Vpk/60 Vdc or current exceeds 8A maximum. Maximum voltage for hands free use: 2500 Vdc. Do not use on circuits where transient stresses can exceed the rated voltage. 5A, +122°F (+50°C) max.

*Std. Colors: -0 Black, -2 Red.

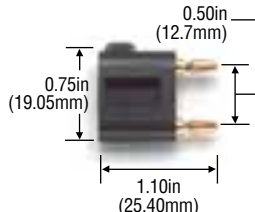

敏盛企業有限公司

http://www.mavin.com.tw

免責聲明

資料僅供參考，若有與原廠不合之處，請以原廠規格為準，且不提供任何證明文件之用

TEL:03-5970828 FAX:03-5972622 新竹湖口工業區工業四路3號2F

Miniature Double Banana Plug Shorting Bar

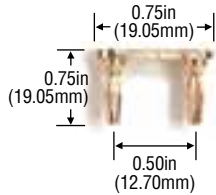

Model# 3030

Center hole accepts 4-40 screw.
Material: *Banana Plug Body:* brass; *Spring:* beryllium copper; *Finish:* gold plating.
Rating: 5A. Resistance less than 1.5 mΩ.
 Fits Miniature Binding Posts and Miniature Banana Jacks on 0.5in (12.70mm) centers.

Miniature Rivet Type Banana Plug

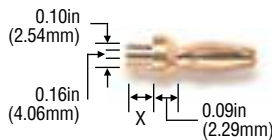

Model#	Panel	X Dim.
3268	0.062in (1.57mm)	0.094in (2.39mm)
3271	0.093in (2.36mm)	0.125in (3.17mm)
3272	0.125in (3.17mm)	0.156in (3.96mm)

Fits miniature 0.104in (2.64mm) dia. banana jacks.
Material: *Banana Plug Body:* brass; *Spring:* beryllium copper; *Finish:* gold plating.
Rating: For CE compliance and for personal safety, do not hold in hand when voltages exceed 30 Vrms/42.4 Vpk/60 Vdc or current exceeds 8A maximum. Maximum voltage for *hands free use:* 2500 Vdc. Do not use on circuits where transient stresses can exceed the rated voltage. 5A.
 Sold in pkgs. of 10.

Miniature Binding Post

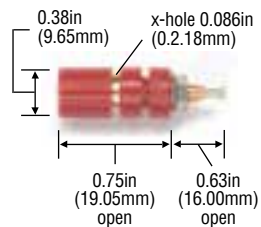

Model#	Plating
2382-*	Gold
2439-*	Tin

Accepts miniature banana plug.
 8-32 hex nut and lockwasher included.
Material: *Binding Post Body, Nut:* brass; *Lockwasher:* steel; *Insulation:* polycarbonate.
Rating: For CE compliance and for personal safety, do not hold in hand when voltages exceed 30 Vrms/42.4 Vpk/60 Vdc or current exceeds 8A maximum. Maximum voltage for *hands free use:* 1500 Vdc. Do not use on circuits where transient stresses can exceed the rated voltage. 5A, +239°F (+115°C) max.
***Std. Colors:** -0 Black, -2 Red, -5 Green, -6 Blue.
 Replacement hex nuts available on page 39.

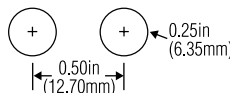

Panel Cut-Out

Miniature Banana Jack with Wire Wrap Terminal

Model# 4022-*

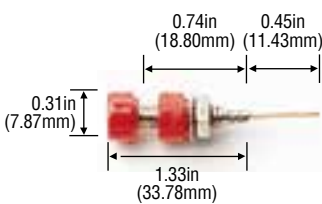

Accepts miniature banana plugs.
 Mounts in panels up to 0.250in (6.35mm) thick.
Material: *Jack:* nickel-plated brass; *Terminal:* gold-plated phosphor bronze; *Insulation:* polycarbonate.
Rating: For CE compliance and for personal safety, do not hold in hand when voltages exceed 30 Vrms/42.4 Vpk/60 Vdc or current exceeds 8A maximum. Maximum voltage for *hands free use:* 1500 Vdc. Do not use on circuits where transient stresses can exceed the rated voltage. 3A, +239°F (+115°C) max.
***Std. Colors:** -0 Black, -2 Red.
 Sold unassembled, in pkgs. of 10.

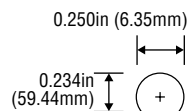

Panel Cut-Out

Miniature Insulated Binding Post with Double Mounting Base

Model#	Plating
2383-*	Gold
2440-*	Tin

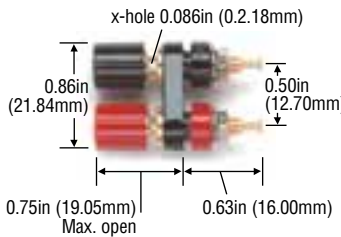

Accepts miniature banana plugs.
 8-32 hex nut and lockwasher included.
Material: *Binding Post Body, Nut:* brass; *Lockwasher:* steel; *Insulation:* polycarbonate.
Rating: For CE compliance and for personal safety, do not hold in hand when voltages exceed 30 Vrms/42.4 Vpk/60 Vdc or current exceeds 8A maximum. Maximum voltage for *hands free use:* 1500 Vdc. Do not use on circuits where transient stresses can exceed the rated voltage. 5A, +239°F (115°C) max.
***Mounting Base Colors:** -0 Black, -2 Red.
***Std. Colors:** 2383: -0 Black, -2 Red. 2440: -0 Black.
 Replacement hex nuts available on page 39.

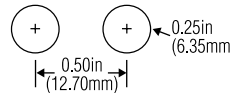

Panel Cut-Out

Do-It-Yourself Pin Tip Plug with Safety Shield, Stackable, Solderless

Model# 3548-*

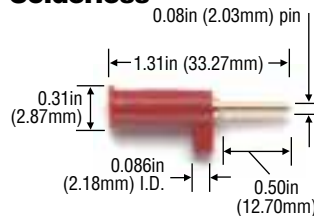

Accepts miniature banana plug.
 Wire firmly held in place with internal set screw.
Material: *Pin Tip Plug/Jack:* gold-plated brass; *Insulation:* ABS.
Rating: For CE compliance and for personal safety, do not hold in hand when voltages exceed 30 Vrms/42.4 Vpk/60 Vdc or current exceeds 8A maximum. Maximum voltage for *hands free use:* 3000 Vdc. Do not use on circuits where transient stresses can exceed the rated voltage. 5A, +122°F (+50°C) max.
***Std. Colors:** -0 Black, -2 Red.

Miniature Banana Jack, Panel Mount

Model# 2142-*

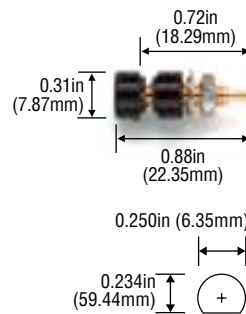

Accepts miniature banana plugs. Mounts in panels up to 0.250in (6.35mm) thick.
Material: gold-plated brass; *Insulation:* polycarbonate.
Rating: For CE compliance and for personal safety, do not hold in hand when voltages exceed 30 Vrms/42.4 Vpk/60 Vdc or current exceeds 8A maximum. Maximum voltage for *hands free use:* 1500 Vdc. Do not use on circuits where transient stresses can exceed the rated voltage. 5A, +239°F (+115°C) max.
***Std. Colors:** -0 Black, -2 Red, -3 Orange, -4 Yellow, -5 Green, -6 Blue, -9 White.
 Uses hex nut 6440.
 Replacement hex nuts available on page 39.
 Sold unassembled, in pkgs. of 10 per color.

Panel Cut-Out

Miniature Rivet Type Banana Jack with Turret

Model# 3277

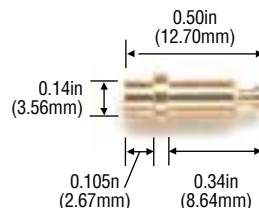

Accepts miniature banana plugs.
 Mounts in panels up to 0.062in (1.57mm) thick.
Material: Gold-plated brass.
Rating: For CE compliance and for personal safety, do not hold in hand when voltages exceed 30 Vrms/42.4 Vpk/60 Vdc or current exceeds 8A maximum. Maximum voltage for *hands free use:* 1500 Vdc. Do not use on circuits where transient stresses can exceed the rated voltage. 5A.
 Sold in pkgs. of 10.
Rec. Mounting Hole: .140 ± .002 (9/64 Drill).
Panel Thickness: 0.062in (1.57mm)

Miniature Banana Jack in Double Mounting Base, Panel Mount

Model# 2143-*

Accepts miniature banana plugs. Mounts in panels up to 0.188in (4.78mm) thick.

Material: gold-plated brass; *Insulation:* polycarbonate.

Rating: For CE compliance and for personal safety, do not hold in hand when voltages exceed 30 Vrms/42.4 Vpk/60 Vdc or current exceeds 8A maximum. Maximum voltage for hands free use: 1500 Vdc. Do not use on circuits where transient stresses can exceed the rated voltage. 5A, +239°F (+115°C) max.

*Std. Mounting Base Colors: -0 Black, -2 Red.

Colors: One black and one red jack.

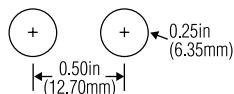
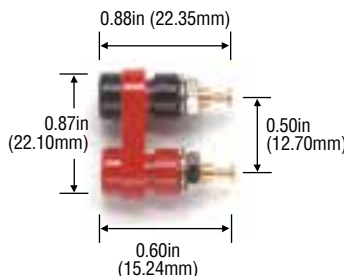

Panel Cut-Out

Double Pin Tip Plug with Shorting Bar

Model# 3452-*

Accepts pin tip plugs. Internally shorted with 20 AWG wire. Use as connecting link for 0.50in (12.70mm) spaced pin tip jacks.

Material: Pin Tip Plug/Jack: brass; Spring: beryllium copper; Finish: gold plating; *Insulation:* ABS.

Rating: For CE compliance and for personal safety, do not hold in hand when voltages exceed 30 Vrms/42.4 Vpk/60 Vdc or current exceeds 8A maximum. Maximum voltage for hands free use: 3000 Vdc. Do not use on circuits where transient stresses can exceed the rated voltage. 5A, +239°F (+115°C) max.

*Std. Colors: -0 Black, -2 Red.

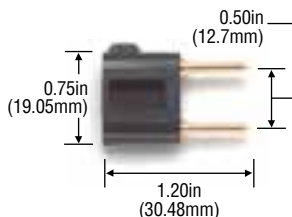

Do-It-Yourself .080in (20.32mm) Dia. Pin Tip Plug with Flexible Boot, Solder or Crimp

Model#	Accepts Wire AWG
5173-*	22, 20, 18

Ideal for making patch cords or field repairs. Snap-on flexible PVC boot allows wire to be crimped or soldered to pin tip plug.

Material: nickel-plated brass.

Accepts 18-22 AWG wire.

Rating: For CE compliance and for personal safety, do not hold in hand when voltages exceed 30 Vrms/42.4 Vpk/60 Vdc or current exceeds 8A maximum. Maximum voltage for hands free use: 3000 Vdc. Do not use on circuits where transient stresses can exceed the rated voltage. 5A, +122°F (+50°C) max.

*Std. Colors: Available in 10 colors.

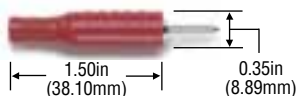

Double Banana Jack to Miniature Double Banana Plug Plug

Model# 2952

Converts standard banana plugs to miniature.

Material: Jack: nickel-plated brass; Spring: nickel-plated beryllium copper; *Insulation:* ABS.

Rating: For CE compliance and for personal safety, do not hold in hand when voltages exceed 30 Vrms/42.4 Vpk/60 Vdc or current exceeds 8A maximum. Maximum voltage for hands free use: 2500 Vdc. Do not use on circuits where transient stresses can exceed the rated voltage. 5A, +122°F (+50°C) max.

Color: Black.

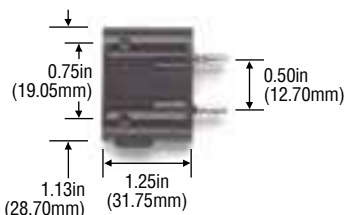

Pin Tip Jacks with Double Mounting Base

Model# 4543-*

Accepts 0.08in (2.03mm) dia. pin.

Max. panel thickness 0.188in (4.78mm).

Material: Jack: gold-plated brass; Spring: beryllium copper; *Insulation:* polycarbonate.

Rating: For CE compliance and for personal safety, do not hold in hand when voltages exceed 30 Vrms/42.4 Vpk/60 Vdc or current exceeds 8A maximum. Maximum voltage for hands free use: 1500 Vdc. Do not use on circuits where transient stresses can exceed the rated voltage. 5A, +239°F (115°C) max.

*Mtg. Base Colors: -0 Black, -2 Red.

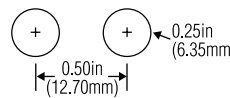
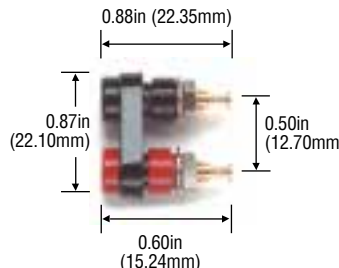

Panel Cut-Out

Pin Tip Jack

Model# 3542-*

Accepts 0.080in (2.03mm) dia. pin.

Material: Jack: gold-plated brass; Spring: beryllium copper; *Insulation:* polycarbonate.

Rating: For CE compliance and for personal safety, do not hold in hand when voltages exceed 30 Vrms/42.4 Vpk/60 Vdc or current exceeds 8A maximum. Maximum voltage for hands free use: 1500 Vdc. Do not use on circuits where transient stresses can exceed the rated voltage. 5A, +239°F (115°C) max.

*Std. Colors: -0 Black, -2 Red, -3 Orange, -4 Yellow, -5 Green, -6 Blue, -9 White.

Sold in pkgs. of 10.

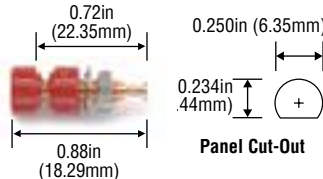

Panel Cut-Out

Insulated Pin Jack with Wire Wrap Terminal

Model# 4773-*

Accepts 0.080in (2.03mm) dia. pin.

Max. panel thickness 0.25in (6.35mm).

Material: Jack: nickel-plated brass; Spring: gold-plated beryllium copper; Terminal: gold-plated phosphor bronze; *Insulation:* polycarbonate.

Rating: For CE compliance and for personal safety, do not hold in hand when voltages exceed 30 Vrms/42.4 Vpk/60 Vdc or current exceeds 8A maximum. Maximum voltage for hands free use: 1500 Vdc. Do not use on circuits where transient stresses can exceed the rated voltage. 3A, +239°F (+115°C) max.

*Std. Colors: -0 Black, -2 Red, -6 Blue, -9 White.

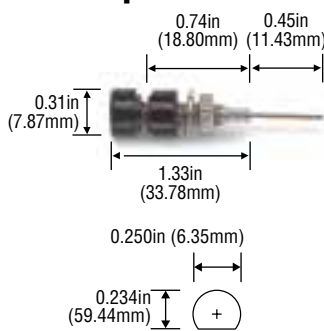

Panel Cut-Out

Miniature Banana Jack to Banana Plug

Model# 2477-*

Converts miniature banana plugs to standard.

Material: Jack: nickel-plated brass; Spring: nickel-plated beryllium copper; *Insulation:* ABS.

Rating: For CE compliance and for personal safety, do not hold in hand when voltages exceed 30 Vrms/42.4 Vpk/60 Vdc or current exceeds 8A maximum. Maximum voltage for hands free use: 2500 Vdc. Do not use on circuits where transient stresses can exceed the rated voltage. 5A, +122°F (+50°C) max.

*Std. Color: -0 Black, -2 Red.

Sold in pkgs. of 10.

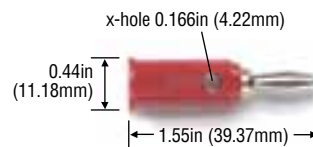

*Color Code: -0 Black, -1 Brown, -2 Red, -3 Orange, -4 Yellow, -5 Green, -6 Blue, -7 Violet, -8 Gray, -9 White

Do-It-Yourself In-Line 4 mm (0.16in) Banana Plug

Model# 5934-*

Wire connection by set screw. Accepts 18, 20 and 22 AWG wire.

Material: *Insulation:* Nylon.

Rating: For CE compliance and for personal safety, do not hold in hand when voltages exceed 30 Vrms/42.4 Vpk/60 Vdc or current exceeds 8A maximum. Maximum voltage for *hands free use:* 750 Vdc. Do not use on circuits where transient stresses can exceed the rated voltage.25A.

***Std. Colors:** -0 Black, -2 Red.

Sold in pkgs. of 10 per color.

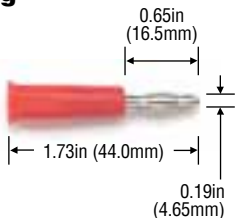

Pin Tip Jack to Banana Plug

Model# 1809-*

Accepts 0.080in (2.03mm) pin tip plug or probe tip. Fits standard 0.166in (4.22mm) dia. banana jack.

Material: gold-plated beryllium copper.

Rating: For CE compliance and for personal safety, do not hold in hand when voltages exceed 30 Vrms/42.4 Vpk/60 Vdc or current exceeds 8A maximum. Maximum voltage for *hands free use:* 2500 Vdc. Do not use on circuits where transient stresses can exceed the rated voltage.5A, +122°F (+50°C) max.

***Std. Color:** -0 Black, -2 Red.

Sold in pkgs. of 10.



Banana Jack to Pin Tip Plug

Model# 1432-*

Use to mate standard banana plug patch cords to equipment having pin jacks.

Material: *Jack/Plug:* nickel-plated brass; *Insulation:* polypropylene.

Rating: For CE compliance and for personal safety, do not hold in hand when voltages exceed 30 Vrms/42.4 Vpk/60 Vdc or current exceeds 8A maximum. Maximum voltage for *hands free use:* 3000 Vdc. Do not use on circuits where transient stresses can exceed the rated voltage. 5A, +122°F (+50°C) max.

***Std. Colors:** -0 Black, -2 Red.

Sold in pkgs. of 10.

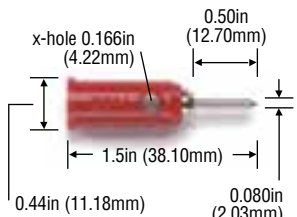

Banana Jack to .080in (2mm) Dia. Pin Tip Jack

Model# 3834-*

Adapts standard 0.166in (4.22mm) dia. banana plug to 0.080in (2.03mm) dia. pin tip plug.

Material: *Banana Jack:* nickel-plated brass; *Pin Jack:* gold-plated beryllium copper; *Insulation:* polypropylene.

Rating: For CE compliance and for personal safety, do not hold in hand when voltages exceed 30 Vrms/42.4 Vpk/60 Vdc or current exceeds 8A maximum. Maximum voltage for *hands free use:* 3000 Vdc. Do not use on circuits where transient stresses can exceed the rated voltage. 5A, +131°F (+55°C) max.

***Std Colors:** -0 Black.



2mm Banana Jack

Model# 5935-*

Max. Panel Thickness: 0.31in (8mm).

Material: *Insulation:* nylon; *Finish:* nickel plating.

Rating: For CE compliance and for personal safety, do not hold in hand when voltages exceed 30 Vrms/42.4 Vpk/60 Vdc or current exceeds 8A maximum. Maximum voltage for *hands free use:* 500 Vdc. Do not use on circuits where transient stresses can exceed the rated voltage. 5A, ≤ 2 mΩ.

***Std. Colors:** -0 Black.

Sold in pkgs. of 10 per color.

Not compatible with Miniature Banana Plug or Pin Tip.

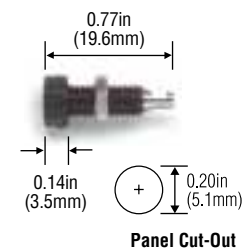

Double Banana Plug with Binding Posts, Stackable, Solderless

Model#	Plating
1286	Nickel
5405	Gold

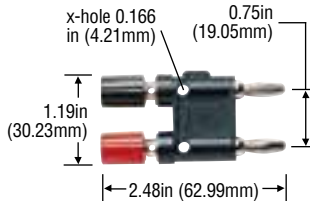

Features insulated binding posts on 0.750in (19.05mm) centers for rapid mounting and interchangeability of components. Center cross hole 0.166in (4.22mm) dia. provides side stackup connection.

Material: *Binding Post/Banana Plug Body:* brass; *Spring:* beryllium copper; *Insulation:* ABS.

Rating: For CE compliance and for personal safety, do not hold in hand when voltages exceed 30 Vrms/42.4 Vpk/60 Vdc or current exceeds 8A maximum. Maximum voltage for *hands free use:* 2500 Vdc. Do not use on circuits where transient stresses can exceed the rated voltage. 15A, +122°F (+50°C) max.

Color: Black.

Banana Jack to Miniature Banana Plug

Model# 2138-*

Use to mate standard 0.166in (4.22mm) dia. banana plug to equipment having miniature banana jacks.

Material: *Jack:* nickel-plated brass; *Spring:* nickel-plated beryllium copper; *Insulation:* ABS.

Rating: For CE compliance and for personal safety, do not hold in hand when voltages exceed 30 Vrms/42.4 Vpk/60 Vdc or current exceeds 8A maximum. Maximum voltage for *hands free use:* 2500 Vdc. Do not use on circuits where transient stresses can exceed the rated voltage.5A, +122°F (+50°C) max.

***Std. Color:** -0 Black, -2 Red.

Sold in pkgs. of 10.

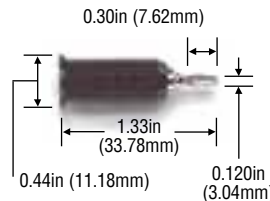

Insulated Double Banana Plug Shorting Bar with Binding Post

Model# 5165-*

Fits standard banana jack.

Shorting bar is completely insulated in clear ABS thermoplastic.

Material: *Binding Post/Banana Plug Body/Shorting Bar:* nickel-plated brass; *Spring:* nickel-plated beryllium copper; *Insulation:* polycarbonate.

Rating: For CE compliance and for personal safety, do not hold in hand when voltages exceed 30 Vrms/42.4 Vpk/60 Vdc or current exceeds 8A maximum. Maximum voltage for *hands free use:* 2500 Vdc. Do not use on circuits where transient stresses can exceed the rated voltage. 15A, +122°F (+50°C) max.

***Binding Post Colors:** -0 Black, -2 Red.

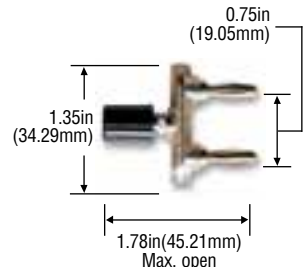

Binding Post to Banana Plug

Model# 2894-*

Features insulated binding post for rapid mounting and interchangeability of components. Accepts standard banana plug. Center cross hole 0.166in (4.220mm) dia. provides side stackup connection.

Material: *Binding Post/Banana Plug Body:* nickel-plated brass; *Spring:* nickel-plated beryllium copper; *Insulation:* polypropylene

Rating: For CE compliance and for personal safety, do not hold in hand when voltages exceed 30 Vrms/42.4 Vpk/60 Vdc or current exceeds 8A maximum. Maximum voltage for *hands free use:* 2500 Vdc. Do not use on circuits where transient stresses can exceed the rated voltage. 15A, +122°F (+50°C) max.

***Binding Post Colors:** -0 Black, -2 Red.



2mm Banana Plug

Model# 5936-*



Solder type wire connection.
Accepts 18-22 AWG wire.

Rating: For CE compliance and for personal safety, do not hold in hand when voltages exceed 30 Vrms/42.4 Vpk/60 Vdc or current exceeds 8A maximum. Maximum voltage for *hands free use*: 500 Vrms. Do not use on circuits where transient stresses can exceed the rated voltage. 5A, $\leq 2\text{ m}\Omega$.

*Std. Colors: -0 Black, -2 Red.

Assembled Length: 1.07in (27.2 mm).

Sold unassembled, in pkgs. of 10 per color.

Not compatible with Miniature Banana Plug or Pin Tip.

Test Connector Adapter Set

Model# 6481

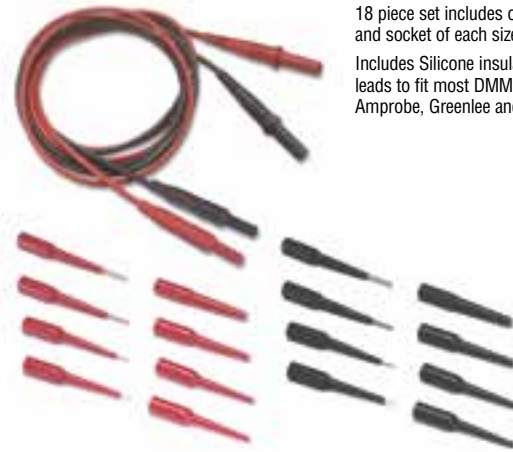

Full set of pin and socket adapters.

18 piece set includes one black and red pin and socket of each size.

Includes Silicone insulated 4ft (1.21m) leads to fit most DMMs from Fluke, Amprobe, Greenlee and others.

Spade Lug to DMM Banana Jack

Model#	A	B	Lug Size
3744A-*	0.14in (3.56mm)	0.24in (6.10mm)	4, 5, 6
3777A-*	0.2in (5.0mm)	0.30in (7.7mm)	8, 10



Plugs into DMM leads. Permits DMM leads to be used with equipment having barrier strips, or binding post.

Material: Banana Jack: nickel-plated brass; Spade Lug: tin-plated copper; Insulation: polypropylene.

Rating: For CE compliance and for personal safety, do not hold in hand when voltages exceed 30 Vrms/42.4 Vpk/60 Vdc or current exceeds 8A maximum. Maximum voltage for *hands free use*: 5000 Vdc. Do not use on circuits where transient stresses can exceed the rated voltage. 15A, +122°F (+50°C) max.

*Std. Colors: -0 Black, -2 Red, -02 Set of one black and one red.

Low Thermal EMF Insulated Spade Lug to Banana Jack

Model# 2305

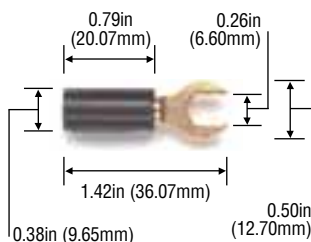

Special alloy and plating preserve the accuracy of low voltage measurement equipment. Thermal effects are minimized. Heavy construction for minimum voltage loss. Mates with low voltage banana plug patch cords and binding posts.

Material: Jack and Spade Lug: gold-plated tellurium copper; Insulation: ABS.

Rating: For CE compliance and for personal safety, do not hold in hand when voltages exceed 30 Vrms/42.4 Vpk/60 Vdc or current exceeds 8A maximum. Maximum voltage for *hands free use*: 5000 Vdc. Do not use on circuits where transient stresses can exceed the rated voltage. 15A, +122°F (+50°C) max.

Set of one red and one black.

Connector Test Adapters

Pin type



Socket type

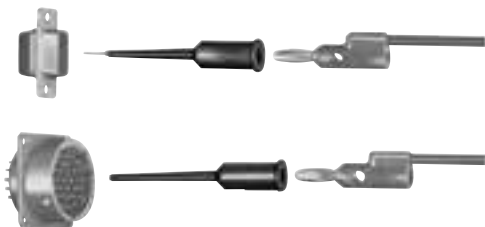

Model#	AWG	Contact Size	Type	Current Rating
4690-*	22	0.030in (0.76mm)	Socket	3A
4691-*			Pin	
3560-*	20	0.040in (1.02mm)	Socket	
3561-*			Pin	
3562-*	16	0.063in (1.60mm)	Socket	
3563-*			Pin	
3564-*	12	0.093in (2.36mm)	Socket	
3565-*			Pin	

An ideal test adapter for rapid testing of the hard-to-get at contacts of multi-pin/socket connectors. Flexible tip allows testing of adjacent contacts. Flexibility and full insulation protects against shorting or contact damage. Model 4690 also fits 0.025in (0.63mm) sq. pins.

Material: Banana Jack: nickel-plated brass; Socket: gold-plated copper; Pin: gold-plated brass; Insulation: PVC.

Rating: For CE compliance and for personal safety, do not hold in hand when voltages exceed 30 Vrms/42.4 Vpk/60 Vdc or current exceeds 8A maximum. Maximum voltage for *hands free use*: 2500 Vdc. Do not use on circuits where transient stresses can exceed the rated voltage. +122°F (+50°C) max.

*Std. Colors: -0 Black, -2 Red.

Patch Cords and Test Leads

Pomona has made it easy for you to have exactly what you need with a huge selection of patch cords and test leads designed for reliable, convenient connections. Whether you need a test lead that can access an IC pin without shorting or a patch cord that accommodates multiple stacking, Pomona Electronics' design and reliability are your connection with quality.

Wire Specifications

Wire Designation	AWG	Description	O.D.	Jacket	Temperature Range	Color
B	18	65/36 copper	0.144in (3.66mm)	PVC	-4 to 221°F (-20 to +105°C)	10 Colors
Silicone	18	65/36 copper	0.144in (3.66mm)	Silicone	-58 to 302°F (-50 to +150°C)	Black and Red
P	20	41/35 copper	0.087in (2.20mm)	PVC	-4 to 221°F (-20 to +105°C)	10 colors
PTO	22	26/36 copper	0.064in (1.62mm)	PVC	-4 to 221°F (-20 to +105°C)	10 colors
	12	7 x 38/36 copper	0.144in (3.66mm)	PVC	140°F (+60°C)	Black, Red, Green

How To Order

Typical Pomona Part Number: **3781-24-2**
 Lead Length in Inches (Measured Inside Connectors)
 Specify Color

Multi-Stacking Banana Plug Patch Cord

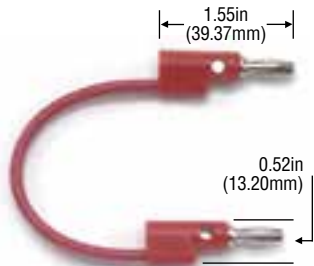

Model#	Length
B-4-*	4in (0.1m)
B-8-*	8in (0.2m)
B-12-*	12in (0.3m)
B-18-*	18in (0.5m)
B-24-*	24in (0.6m)
B-36-*	36in (0.9m)
B-48-*	48in (1.2m)
B-60-*	60in (1.5m)
B-72-*	72in (1.8m)

Model B: Multi-Stacking Banana Plug Patch Cord features a nickel-plated finish.

Cable: 18 AWG Wire, 0.144in (3.56mm) O.D.

Rating: For CE compliance and for personal safety, do not hold in hand when voltages exceed 30 Vrms/42.4 Vpk/60 Vdc or current exceeds 8A maximum. Maximum voltage for *hands free use:* 5000 Vdc. Do not use on circuits where transient stresses can exceed the rated voltage. 15A, +131°F (+55°C) max.

*Std. Colors: Available in 10 Colors.

Model#	Length	Special Features
2948-12-*	12in (0.3m)	Gold-plated finish
2948-24-*	24in (0.6m)	
2948-36-*	36in (0.9m)	
2948-48-*	48in (1.2m)	
2948-60-*	60in (1.5m)	

Model 2948 Multi-Stacking Banana Plug Patch Cord features a gold-plated finish.

*Std. Colors: -0 Black, -2 Red.

Horizontal Stacking Banana Plug Patch Cord



Model#	Length
HB-12-*	12in (0.3m)
HB-24-*	24in (0.6m)
HB-36-*	36in (0.9m)
HB-48-*	48in (1.2m)
HB-60-*	60in (1.5m)

Cable: 18 AWG Wire, 0.144in (3.56mm) O.D.

Rating: For CE compliance and for personal safety, do not hold in hand when voltages exceed 30 Vrms/42.4 Vpk/60 Vdc or current exceeds 8A maximum. Maximum voltage for *hands free use:* 5000 Vdc. Do not use on circuits where transient stresses can exceed the rated voltage. 15A, +131°F (+55°C) max.

*Std. Colors: -0 Black, -2 Red.

Test Lead Holders

Model#	Color	"A" Max Cable Dia.	Number of Slots
1508	Orange	0.210in (5.33mm)	14
4408	Black	0.320in (8.13mm)	10
2708	Blue	0.450in (11.43mm)	9

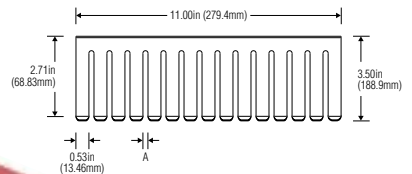

Multi-stacking Sheathed (4mm) Banana Plug Patch Cord



Model# 6727-*

4ft (1.2 meter) stackable safety lead.

Material: Contacts: nickel-plated brass; Wire: multi-strand copper,

Insulation: silicone.

Rating: IEC61010 1000V Cat III, 20A max (10A cont.), 14 to 131°F (-10 to +55°C).

*Std. Colors: -0 Black only, -2 Red only.

Cross Stacking Banana Plug Patch Cord



Model#	Length
1440-12-*	12in (0.3m)
1440-18-*	18in (0.5m)
1440-24-*	24in (0.6m)
1440-36-*	36in (0.9m)
1440-48-*	48in (1.2m)
1440-60-*	60in (1.5m)

Cable: 18 AWG Wire, 0.144in (3.56mm) O.D.

Rating: For CE compliance and for personal safety, do not hold in hand when voltages exceed 30 Vrms/42.4 Vpk/60 Vdc or current exceeds 8A maximum. Maximum voltage for *hands free use:* 5000 Vdc. Do not use on circuits where transient stresses can exceed the rated voltage. 15A, +131°F (+55°C) max.

*Std. Colors: -0 blk, -2 red.

Multi-Stacking Banana Plug Coiled Patch Cord



1.55in (39.37mm)

Model#	Ext. Length
2484*	48in (1.23mm)

Cable: 20 AWG Wire, 0.087in (2.21mm) O.D.

Extended Length: 48in (1.2mm).

One patch cord replaces many different lengths.

Rating: For CE compliance and for personal safety, do not hold in hand when voltages exceed 30 Vrms/42.4 Vpk/60 Vdc or current exceeds 8A maximum. Maximum voltage for *hands free use:* 270 Vdc. Do not use on circuits where transient stresses can exceed the rated voltage. 5A, +131°F (+55°C) max.

*Std. Colors: -0 Black, -2 Red.

Multi-Stacking Banana Plug to Minigrabber® Test Clip



1.55in (39.37mm)

Model#	Length
3782-12-*	12in (0.3m)
3782-24-*	24in (0.6m)
3782-36-*	36in (0.9m)
3782-48-*	48in (1.2m)
3782-60-*	60in (1.5m)

Hook attaches to component leads up to 0.060in (1.52mm) O.D.

Cable: 20 AWG Wire, 0.087in (2.21mm) O.D.

Rating: For CE compliance and for personal safety, do not hold in hand when voltages exceed 30 Vrms/42.4 Vpk/60 Vdc or current exceeds 8A maximum. Maximum voltage for *hands free use:* 300V. Do not use on circuits where transient stresses can exceed the rated voltage. 5A, +131°F (+55°C) max.

*Std. Colors: -0 Black, -2 Red, -4 Yellow, -5 Green, -6 Blue.

Multi-Stacking Banana Plug Patch Cord with In-Line Fuse Holder



1.55in (39.37mm)

Model#	Length
4274-36-*	36in (0.9m)

Cable: 18 AWG Wire, 0.144in (3.56mm) O.D.

Rating: For CE compliance and for personal safety, do not hold in hand when voltages exceed 30 Vrms/42.4 Vpk/60 Vdc or current exceeds 8A maximum. Maximum voltage for *hands free use:* 5000 Vdc. Do not use on circuits where transient stresses can exceed the rated voltage. 15A, +131°F (+55°C).

*Std. Colors: -0 Black, -2 Red.

Multi-Stacking Banana Plug to Minigrabber® Test Clip



1.55in (39.37mm)

Model#	Length
6249-12-*	12in (0.3m)
6249-24-*	24in (0.6m)
6249-36-*	36in (0.9m)

Features a slim 0.36in (9.14mm) body width. Hook attaches to component leads up to 0.060in (1.52mm) O.D.

Cable: 18 AWG Silicone insulated wire, 0.144in (3.56mm) O.D.

Rating: For CE compliance and for personal safety, do not hold in hand when voltages exceed 30 Vrms/42.4 Vpk/60 Vdc or current exceeds 8A maximum. Maximum voltage for *hands free use:* 300V. Do not use on circuits where transient stresses can exceed the rated voltage. 5A.

*Std. Colors: -0 Black, -2 Red.

Multi-Stacking Banana Plug to Miniature Stacking Banana Plug



0.88in (22.35mm)

1.55in (39.37mm)

Model#	Length
3014-36-*	36in (0.9m)
3014-60-*	60in (1.5m)

Cable: 20 AWG Wire, 0.087in (2.21mm) O.D.

Rating: For CE compliance and for personal safety, do not hold in hand when voltages exceed 30 Vrms/42.4 Vpk/60 Vdc or current exceeds 8A maximum. Maximum voltage for *hands free use:* 3000 Vdc. Do not use on circuits where transient stresses can exceed the rated voltage. 5A, +131°F (+55°C) max.

*Std. Colors: -0 Black, -2 Red.

Multi-Stacking Banana Plug to Minigrabber® Test Clip (Coiled) Patch Cord



1.55in (39.37mm)

2.54in (64.52mm)

Model#	Ext. Length
4538-*	48in (1.2m)

Hook attaches to components up to 0.060in (1.52mm) O.D.

Cable: 20 AWG Retractable Cord, 0.087in (2.21mm) O.D.

Rating: For CE compliance and for personal safety, do not hold in hand when voltages exceed 30 Vrms/42.4 Vpk/60 Vdc or current exceeds 8A maximum. Maximum voltage for *hands free use:* 300V. Do not use on circuits where transient stresses can exceed the rated voltage. 5A, +131°F (+55°C).

*Std. Colors: -0 Black, -2 Red.

Multi-Stacking Banana Plug to Maxigrabber® Test Clip

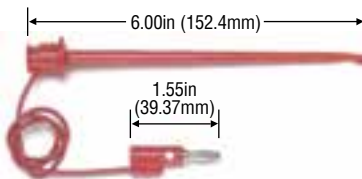

6.00in (152.4mm)

1.55in (39.37mm)

Model#	Length
4996-36-*	36in (0.9m)

Hook attaches to components up to 0.060in (1.52mm) O.D.

Cable: 20 AWG Wire, 0.087in (2.21mm) O.D.

Rating: For CE compliance and for personal safety, do not hold in hand when voltages exceed 30 Vrms/42.4 Vpk/60 Vdc or current exceeds 8A maximum. Maximum voltage for *hands free use:* 300V. Do not use on circuits where transient stresses can exceed the rated voltage. 5A, +131°F (+55°C) max.

*Std. Colors: -0 Black, -2 Red.

Right Angle Stacking Banana Plug Patch Cord



0.89in (22.60mm)

Model#	Length
2864-24-*	24in (0.6m)

Cable: 18 AWG Wire, 0.14in (3.56mm) O.D.

Rating: For CE compliance and for personal safety, do not hold in hand when voltages exceed 30 Vrms/42.4 Vpk/60 Vdc or current exceeds 8A maximum. Maximum voltage for *hands free use:* 5000 Vdc. Do not use on circuits where transient stresses can exceed the rated voltage. 15A, +131°F (+55°C) max.

*Std. Colors: -0 Black, -2 Red.

*Color Code: -0 Black, -1 Brown, -2 Red, -3 Orange, -4 Yellow, -5 Green, -6 Blue, -7 Violet, -8 Gray, -9 White

Multi-Stacking Banana Plug to Micrograbber® Test Clip

Model#	Length
5053-24-*	24in (0.6m)
5053-36-*	36in (0.9m)
5053-48-*	48in (1.2m)



Hook attaches to components up to 0.040in (1.02mm) O.D.

Cable: 20 AWG Wire, 0.087in (2.21mm) O.D.

Rating: For CE compliance and for personal safety, do not hold in hand when voltages exceed 30 Vrms/42.4 Vpk/60 Vdc or current exceeds 8A maximum. Maximum voltage for hands free use: 150V. Do not use on circuits where transient stresses can exceed the rated voltage. 3A, +131°F (+55°C) max.

*Std. Colors: -0 Black, -2 Red.

Multi-Stacking Banana Plug to SMD Grabber® Test Clip

Model#	Length
5302-12-*	12in (0.3m)
5302-24-*	24in (0.6m)
5302-36-*	36in (0.9m)



Pincer Opening: 0.040in (1.02mm).

Cable: 22 AWG Wire, 0.064in (1.63mm) O.D.

Rating: For CE compliance and for personal safety, do not hold in hand when voltages exceed 30 Vrms/42.4 Vpk/60 Vdc or current exceeds 8A maximum. Maximum voltage for hands free use: 150V. Do not use on circuits where transient stresses can exceed the rated voltage. 0.5A, +131°F (+55°C) max.

*Std. Colors: -0 Black, -2 Red.

Minigrabber® Test Clip with Sheathed

Model#	Plug Type	Ratings
6248-12-*	Sheathed Banana Jack	IEC61010-031 CAT II 300V



Test Lead Extender.

Silicone insulated 1ft (0.3m) leads fit on the end of modular test leads such as Pomona 5907A.

Std. Colors: -0 Black, -2 Red.

Double Banana Plug with Safety Shrouds

Model#	Length
6283-C-36	36in (0.9m)
6283-C-48	48in (1.2m)
6283-C-60	60in (1.5m)



Fits Digital Multi-meters and other instruments with shrouded jacks.

Offset design designates hot and ground leads.

Black and red banana plug shrouds.

Molded strain relief for long life.

MIL spec coaxial cable.

Overvoltage CAT II, 600V, 5A per IEC61010-031.

Minigrabber® Test Clip Leads



6244



5428/6231



6245

Model#	Plug Type	Ratings
6244-48-*	Right-angle DMM	CAT II 300V
5428-48-*	Right-angle DMM	300 Vrms*
6231	Right-angle DMM	300 Vrms*
6245-48-*	Straight DMM	CAT II 300V

Silicone insulated 4ft (122m) leads fit most meters from Fluke, Wavetek (Meterman), HP, Amprobe, Greenlee and others

Std. Colors: -0 Black, -2 Red

*Rating: For CE compliance and for personal safety, do not hold in hand when voltages exceed 30 Vrms/42.4 Vpk/60 Vdc or current exceeds 8A maximum. Maximum voltage for hands free use: 300 Vrms. Do not use on circuits where transient stresses can exceed the rated voltage.

Multi-Stacking Double Banana Plugs on Retractable (Coiled) Cord

Model#	Extended Length
3864-48	48in (1.2m)
3864-72	72in (1.8m)



Rating: For CE compliance and for personal safety, do not hold in hand when voltages exceed 30 Vrms/42.4 Vpk/60 Vdc or current exceeds 8A maximum. Maximum voltage for hands free use: 90 Vac/270 Vdc. Do not use on circuits where transient stresses can exceed the rated voltage. +122°F (+50°C) max.

Cable Type: Shielded Microphone Cable.

Multi-Stacking Double to Multi-Stacking Single Banana Plugs

Model#	Length
1368-A-18	18in (0.5m)
1368-A-24	24in (0.6m)
1368-A-30	30in (0.76m)
1368-A-36	36in (0.9m)
1368-A-48	48in (1.2m)
1368-A-60	60in (1.5m)



Rating: For CE compliance and for personal safety, do not hold in hand when voltages exceed 30 Vrms/42.4 Vpk/60 Vdc or current exceeds 8A maximum. Maximum voltage for hands free use: 300 Vrms. Do not use on circuits where transient stresses can exceed the rated voltage. +122°F (+50°C) max.

See chart on page 6 for additional cable specifications.

Two Conductor shielded Balanced Line

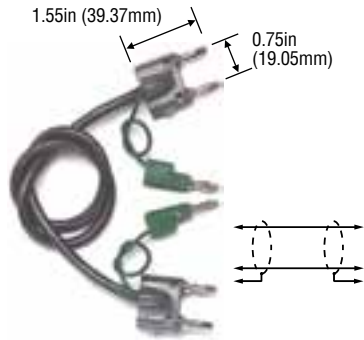

Model#	Length
1167-18	18in (0.5m)
1167-24	24in (0.6m)
1167-30	30in (0.76m)
1167-36	36in (0.9m)
1167-48	48in (1.2m)
1167-60	60in (1.5m)

Rating: For CE compliance and for personal safety, do not hold in hand when voltages exceed 30 Vrms/ 42.4 Vpk/60 Vdc or current exceeds 8A maximum. Maximum voltage for *hands free use*: 1000 Vrms. Do not use on circuits where transient stresses can exceed the rated voltage. +131°F (+55°C) max.

Cable Type I: See chart on page 6 for additional cable specifications.

Multi-Stacking Banana Plugs, Two Each End



Model#	Length
2239-C-24	24in (0.6m)
2239-C-36	36in (0.9m)
2239-C-48	48in (1.2m)

Rating: For CE compliance and for personal safety, do not hold in hand when voltages exceed 30 Vrms/ 42.4 Vpk/60 Vdc or current exceeds 8A maximum. Maximum voltage for *hands free use*: 1400 Vrms. Do not use on circuits where transient stresses can exceed the rated voltage. +131°F (+55°C) Max.

See chart on page 6 for additional cable specifications.



Multi-Stacking Double Banana Plug Cables

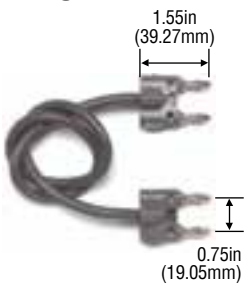

Model#	Cable Type	Length
2BA-18	Two Conductor Twisted Pair, 18 AWG, 0.25in (6.35mm) O.D.	18in (0.5m)
2BA-24		24in (0.6m)
2BA-36		36in (0.9m)
2BA-48		48in (1.2m)
2BA-60		60in (1.5m)
2BC-24	RG58C/U, 0.195in (4.95mm) O.D.	24in (0.6m)
2BC-36		36in (0.9m)
2BC-48		48in (1.2m)
2BC-60		60in (1.5m)

Rating: For CE compliance and for personal safety, do not hold in hand when voltages exceed 30 Vrms/42.4 Vpk/ 60 Vdc or current exceeds 8A maximum. Maximum voltage for *hands free use*: 2BA: 300 Vrms, 2BC: 1400 Vrms. Do not use on circuits where transient stresses can exceed the rated voltage. +131°F (+50°C) max.

Multi-Stacking Double Banana Plug to Minigrabber® Test Clips



Model#	Length
3786-C-18	18in (0.5m)
3786-C-24	24in (0.6m)
3786-C-36	36in (0.9m)
3786-C-48	48in (1.2m)
3786-C-60	60in (1.5m)

Rating: For CE compliance and for personal safety, do not hold in hand when voltages exceed 30 Vrms/42.4 Vpk/60 Vdc or current exceeds 8A maximum. Maximum voltage for *hands free use*: 300 Vrms. Do not use on circuits where transient stresses can exceed the rated voltage. +122°F (+50°C) max.

See chart on page 6 for additional cable specifications.

Double Banana Plug to Micrograbber® Test Clips

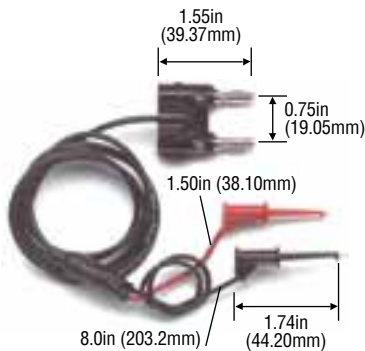

Model#	Length
4768-K-24	24in (0.6m)
4768-K-36	36in (0.9m)
4768-K-48	48in (1.2m)
4768-K-60	60in (1.5m)

Rating: For CE compliance and for personal safety, do not hold in hand when voltages exceed 30 Vrms/42.4 Vpk/60 Vdc or current exceeds 8A maximum. Maximum voltage for *hands free use*: 150 Vrms. Do not use on circuits where transient stresses can exceed the rated voltage. +122°F (+50°C) max.

See chart on page 6 for additional cable specifications.

Multi-Stacking Double Banana Plug, One End Only



Model#	Length
1326-A-60	60in (1.5m)
1326-C-60	60in (1.5m)

Rating: For CE compliance and for personal safety, do not hold in hand when voltages exceed 30 Vrms/42.4 Vpk/60 Vdc or current exceeds 8A maximum. Maximum voltage for *hands free use*: A: 300 Vrms, C: 1400 Vrms. Do not use on circuits where transient stresses can exceed the rated voltage. +131°F (+55°C) max.

See chart on page 6 for additional cable specifications.

Double Banana Plug to Stacking Pin Tip Plugs

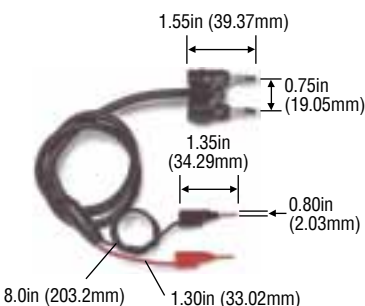

Model#	Length
2BC-PP-36	36in (0.9m)
2BC-PP-48	48in (1.2m)
2BC-PP-60	60in (1.5m)

Cable Type: RG58C/U 0.195in (4.95mm) O.D.

Rating: For CE compliance and for personal safety, do not hold in hand when voltages exceed 30 Vrms/ 42.4 Vpk/60 Vdc or current exceeds 8A maximum. Maximum voltage for *hands free use*: 1400 Vrms. Do not use on circuits where transient stresses can exceed the rated voltage. +122°F (+50°C) max.

Miniature Double Banana Plug Cable

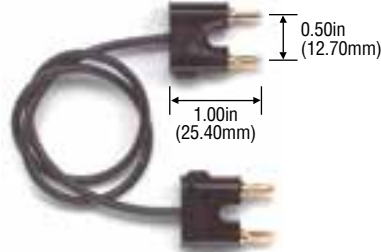

Model#	Length
2247-K-24	24in (0.6m)

Rating: For CE compliance and for personal safety, do not hold in hand when voltages exceed 30 Vrms/42.4 Vpk/60 Vdc or current exceeds 8A maximum. Maximum voltage for *hands free use*: 1000 Vrms. Do not use on circuits where transient stresses can exceed the rated voltage. +131°F (+55°C) max.

Cable Type: RG174/U, 0.100in (2.54mm) O.D.

*Color Code: -0 Black, -1 Brown, -2 Red, -3 Orange, -4 Yellow, -5 Green, -6 Blue, -7 Violet, -8 Gray, -9 White

Double Banana Plug to Minigator Test Clips



Model#	Length
2BC-MG-36	36in (0.9m)

Cable Type: RG58C/U.
Rating: For CE compliance and for personal safety, do not hold in hand when voltages exceed 30 Vrms/42.4 Vpk/60 Vdc or current exceeds 8A maximum. Maximum voltage for *hands free use*: 45 Vrms. Do not use on circuits where transient stresses can exceed the rated voltage. +122°F (+50°C) max.
Jaw Opening: 0.187in (4.75mm) max.

Double Banana Plug to Alligator Test Clips



Model#	Length
2BA-AL-36	36in (0.9m)
2BA-AL-48	48in (1.2m)

Cable Type: Two cond. Twisted Pair.
Cable Type: RG58C/U50.
Rating: For CE compliance and for personal safety, do not hold in hand when voltages exceed 30 Vrms/42.4 Vpk/60 Vdc or current exceeds 8A maximum. Maximum voltage for *hands free use*: 150 Vrms. Do not use on circuits where transient stresses can exceed the rated voltage. +122°F (+50°C) max.
Jaw Opening: 0.30in (7.62mm) max.

Jumper Test Lead Set

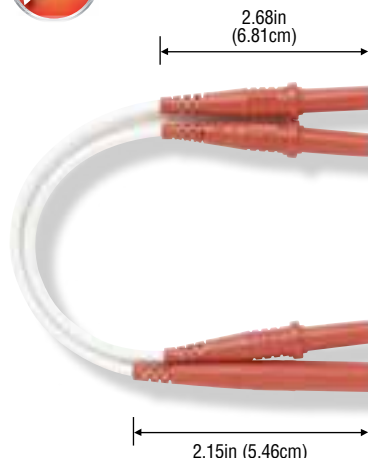

Model#	Length
73087-6-*	6in (0.15m)
73087-9-4	9in (0.23m)
73087-12-*	12in (0.3m)
73087-20-4	20in (0.5m)
73087-24-*	24in (0.6m)
73087-36-*	36in (0.9m)
73087-72-*	72in (1.8m)
73087-150-4	150in (3.8m)
73087-210-4	210in (5.3m)

Each Jumper Test Lead Set includes a Sheathed (4mm) Banana Plug Test Lead, and Sheathed Banana Plug to Sheathed Banana Jack Patch Cord.
Cable: 18 AWG Wire, 0.146in (3.7mm) O.D.
Insulation: Silicone
Rating: For CE Compliance and for personal safety, do not hold in hand when voltages exceed 30 Vrms/42.4 Vpk/60 Vdc or current exceeds 8A maximum. Maximum voltage for *hands free use*: 1000 Vrms. Do not use on circuits where transient stresses can exceed the rated voltage. 10A, -4° to +131°F (-20° to +55°C).
***Std. Colors:** -0 Black, -2 Red, -4 Yellow, -6 Blue.

Minigator Clips to Miniature Double Banana Plug



Model#	Length
3027-K-24	24in (0.6m)

Rating: For CE compliance and for personal safety, do not hold in hand when voltages exceed 30 Vrms/42.4 Vpk/60 Vdc or current exceeds 8A maximum. Maximum voltage for *hands free use*: 45 Vrms. Do not use on circuits where transient stresses can exceed the rated voltage. +122°F (+50°C) max.
Jaw Opening: 0.187in (4.75mm)
 See chart on page 6 for additional cable specifications.

Minigrabber® Test Clip Patch Cord



Model#	Length
3781-8-*	8in (0.2m)
3781-12-*	12in (0.3m)
3781-18-*	18in (0.5m)
3781-24-*	24in (0.6m)
3781-36-*	36in (0.9m)
3781-48-*	48in (1.2m)
3781-60-*	60in (1.5m)

Hook attaches to component leads up to 0.060in (1.52mm) O.D.
Cable: 20 AWG Wire, 0.087in (2.21mm) O.D.
Rating: For CE compliance and for personal safety, do not hold in hand when voltages exceed 30 Vrms/42.4 Vpk/60 Vdc or current exceeds 8A maximum. Maximum voltage for *hands free use*: 300V. Do not use on circuits where transient stresses can exceed the rated voltage. 5A, +216°F (+102°C) max.
***Std. Colors:** Available in 10 colors.

Minigrabber® Test Clip Patch Cord Kit

Model# 5523
 Kit contains 10 pcs. of Model 3781-24, one of each color.

One End Only

Model#	Length
3780-60-*	60in (1.5m)

***Std. Colors:** -0 Black, -2 Red.



Low Thermal EMF Patch Cords

Special alloy plating and construction preserve the accuracy of microvolt and nanovolt measurement equipment. Designed to greatly minimize the effect of Thermal Electric Voltage (Thermal EMF). Thermal EMF is generated at the junction of dissimilar metals at different temperatures and is common source of error in micro- and nano- volt measurements.

Shielded Low Thermal EMF Spade Lug Patch Cord

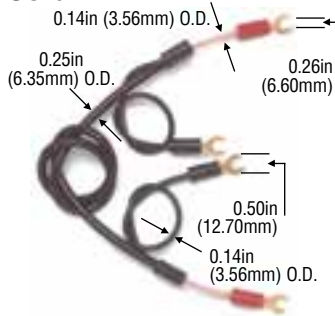

Model#	Length
1756-24	24in (0.6m)
1756-48	48in (1.2m)

Cable: 12 AWG Wire, Shield Leads: 18 AWG.

Material: Spade Lug: gold-plated Electrolytic Tough Pitch (ETP) 110 Copper Alloy, 1/2 hard.

Rating: For CE compliance and for personal safety, do not hold in hand when voltages exceed 30 Vrms/42.4 Vpk/60 Vdc or current exceeds 8A maximum. Maximum voltage for *hands free use*: 2000 Vdc. Do not use on circuits where transient stresses can exceed the rated voltage. 20A, 131°F (+55°C) max.

Low Thermal EMF Spade Lug Patch Cord



Model#	Length
1693-36-*	36in (0.9m)
1693-60-*	60in (1.5m)

Cable: 12 AWG Wire, 0.144in (3.56mm) O.D.
Material: Spade Lug: gold-plated Electrolytic Tough Pitch (ETP) 110 Copper Alloy, 1/2 hard.

Rating: For CE compliance and for personal safety, do not hold in hand when voltages exceed 30 Vrms/42.4 Vpk/60 Vdc or current exceeds 8A maximum. Maximum voltage for *hands free use*: 2000 Vdc. Do not use on circuits where transient stresses can exceed the rated voltage. 20A, +131°F (+55°C) max.

*Std. Colors: -0 Black, -2 Red.

Low Thermal EMF Retractable Sheath Banana Plug Patch Cord



Model#	Length
5291A-12-*	12in (0.3m)
5291A-36-*	36in (0.9m)
5291A-60-*	60in (1.5m)

Cable: 12 AWG Wire, 0.144in (3.56mm) O.D.

Material: Plug Body: gold-plated tellurium copper; Spring: gold-plated Beryllium Copper.
Rating: 1000V per IEC61010-031, 7A, +131°F (+55°C).

*Std. Colors: -0 Black, -2 Red.

Low Thermal EMF Retractable Sheath Banana Plug to Spade Lug



Model#	Length
5295-36-*	36in (0.9m)

Cable: 12 AWG Wire, 0.144in (3.56mm) O.D.

Material: Spade Lug: gold-plated Electrolytic Tough Pitch (ETP) 110 Copper Alloy, 1/2 hard; Plug End: gold-plated tellurium copper.

Rating: For CE compliance and for personal safety, do not hold in hand when voltages exceed 30 Vrms/42.4 Vpk/60 Vdc or current exceeds 8A maximum. Maximum voltage for *hands free use*: 1000V. Do not use on circuits where transient stresses can exceed the rated voltage. 7A, +131°F (+55°C) max.

*Std. Colors: -0 Black, -2 Red.

SMD Grabber® Test Clip Patch Cord

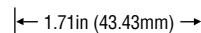

Model#	Length
5301-12-*	12in (0.3m)
5301-24-*	24in (0.6m)

Pincer Opening: 0.04in (1.63mm).

Cable: 22 AWG Wire, 0.064in (1.60mm) O.D.

Rating: For CE compliance and for personal safety, do not hold in hand when voltages exceed 30 Vrms/42.4 Vpk/60 Vdc or current exceeds 8A maximum. Maximum voltage for *hands free use*: 150V. Do not use on circuits where transient stresses can exceed the rated voltage. 0.5A, +216°F (+102°C) max.

*Std. Colors: -0 Black, -2 Red

SMD Grabber® Test Clip Patch Cord Kit

Model# 5521

Kit contains 10 pcs. of Model 5301-24, one each of ten colors.

MicroGrabber® Test Clip Patch Cord



Model#	Length
4613-12-*	12in (0.3m)
4613-24-*	24in (0.6m)
4613-36-*	36in (0.9m)
4613-48-*	48in (1.2m)

Hook attaches to components up to 0.040in (1.02mm) O.D.

20 AWG Wire, 0.087in (2.21mm) O.D.

Rating: For CE compliance and for personal safety, do not hold in hand when voltages exceed 30 Vrms/42.4 Vpk/60 Vdc or current exceeds 8A maximum. Maximum voltage for *hands free use*: 150V. Do not use on circuits where transient stresses can exceed the rated voltage. 3A, +216°F (+102°C) max.

*Std. Colors: -0 Black, -2 Red.

MicroGrabber® Test Clip Patch Cord Kit

Model# 5525

Kit contains 10 pcs. of Model 4613-24, one each of ten colors.

Multi-Stacking Banana Plug to Alligator Test Clip



Model#	Length
1166-12-*	12in (0.3m)
1166-24-*	24in (0.6m)
1166-36-*	36in (0.9m)
1166-48-*	48in (1.2m)
1166-60-*	60in (1.5m)

Jaw Opening: 0.300in (7.62mm).

Cable: 18 AWG Wire, 0.144in (3.56mm) O.D.

Rating: For CE compliance and for personal safety, do not hold in hand when voltages exceed 30 Vrms/42.4 Vpk/60 Vdc or current exceeds 8A maximum. Maximum voltage for *hands free use*: 150V. Do not use on circuits where transient stresses can exceed the rated voltage. 5A, +122°F (+50°C) max.

*Std. Colors: -0 Black, -2 Red.

Banana Plug to Alligator Clip Patch Cord Kit

Model#	Length
6357-36	36in (0.9m)

Kit contains 10 pcs. of Model 1166 patch cords, one each of 10 colors.

*Color Code: -0 Black, -1 Brown, -2 Red, -3 Orange, -4 Yellow, -5 Green, -6 Blue, -7 Violet, -8 Gray, -9 White



敏盛企業有限公司

http://www.mavin.com.tw

免責聲明

資料僅供參考，若有與原廠不合之處，請以原廠規格為準，且不提供任何證明文件之用

TEL:03-5970828 FAX:03-5972622 新竹湖口工業區工業四路3號2F

Minigator Test Clip Patch Cord

Model#	Length
MG-B-12-*	12in (0.3m)
MG-B-24-*	24in (0.6m)



Jaw Opening: 0.187in (4.75mm).
Cable: 18 AWG Wire, 0.144in (3.56mm) O.D.
Rating: For CE compliance and for personal safety, do not hold in hand when voltages exceed 30 Vrms/42.4 Vpk/60 Vdc or current exceeds 8A maximum. Maximum voltage for *hands free use*: 45V. Do not use on circuits where transient stresses can exceed the rated voltage. 5A, +122°F (+50°C) max.

*Std. Colors: -0 Black, -2 Red.

Model#	Length
1236-24-*	24in (0.6m)

Cable: 20 AWG Wire, 0.087in (2.21mm) O.D.
Rating: For CE compliance and for personal safety, do not hold in hand when voltages exceed 30 Vrms/42.4 Vpk/60 Vdc or current exceeds 8A maximum. Maximum voltage for *hands free use*: 45V. Do not use on circuits where transient stresses can exceed the rated voltage. 5A, +122°F (+50°C) max.

*Std. Colors: -0 Black, -2 Red.

1000V Alligator Patch Cord

Model#	Length
6576-24-*	24in (0.6m)
6576-36-*	36in (0.9m)

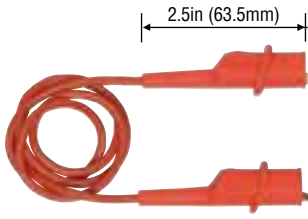

Jaw Opening: 0.300in (7.62mm).
Material: Body: nickel-plated steel; Boot: santoprene rubber.
Cable: 18 AWG Wire, silicone insulated.
Rating: Maximum voltage for *hands free use*: 1000V. 10A, -13 to 176°F (-25°C to 80°C).

*Std. Colors: -0 Black, -2 Red.

Alligator Test Clip Patch Cord

Model#	Length
AL-B-12-*	12in (0.3m)
AL-B-24-*	24in (0.6m)
AL-B-36-*	36in (0.9m)
AL-B-48-*	48in (1.2m)
AL-B-60-*	60in (1.5m)



Jaw Opening: 0.300in (7.62mm).
Cable: 18 AWG Wire, 0.144in (3.56mm) O.D.
Rating: For CE compliance and for personal safety, do not hold in hand when voltages exceed 30 Vrms/42.4 Vpk/60 Vdc or current exceeds 8A maximum. Maximum voltage for *hands free use*: 150V. Do not use on circuits where transient stresses can exceed the rated voltage. 5A, +122°F (+50°C) max.

*Std. Colors: -0 Black, -2 Red.

Alligator Test Clip Patch Cord Kit

Model#	Length	Kit contains
6356-12	12in (0.3m)	10pcs. of Model AL-B patch cords, one each of 10 colors.
6356-24	24in (0.6m)	
6356-36	36in (0.9m)	
6356-60	60in (1.5m)	

5 Way Alligator to Sheathed Right Angle Set

Model#	Length
6483-48-02	48in (1.2m)



Clip includes bed of nails and single needle tip for easy, versatile piercing of wire insulation to contact inner conductor for measurement.

Pierces 19 to 26 AWG wire.

Std. Colors: -0 Black, -2 Red, -02 Set of one black and one red.

Multi-Stacking Banana Plug to Minigator Test Clip

Model#	Length
3220-12-*	12in (0.3m)
3220-24-*	24in (0.6m)
3220-36-*	36in (0.9m)
3220-48-*	48in (1.2m)



Jaw Opening: 0.187in (4.75mm).
Cable: 20 AWG Wire, 0.087in (2.21mm) O.D.
Rating: For CE compliance and for personal safety, do not hold in hand when voltages exceed 30 Vrms/42.4 Vpk/60 Vdc or current exceeds 8A maximum. Maximum voltage for *hands free use*: 45V. Do not use on circuits where transient stresses can exceed the rated voltage. 5A, +122°F (+50°C) max.

*Std. Colors: -0 Black, -2 Red.

Retractable Sheath Banana Plug Patch Cord

Model#	Length
4911A-12-*	12in (0.3m)
4911A-24-*	24in (0.6m)
4911A-36-*	36in (0.9m)
4911A-48-*	48in (1.2m)
4911A-60-*	60in (1.5m)



Cable: 18 AWG Wire, 0.144in (3.56mm) O.D.
Rating: 1000V per IEC61010-031, 10A, +176°F (+80°C) max.

*Std. Colors: -0 Black, -2 Red.

Extra Large Alligator Test Clip to Sheathed Banana Plug Patch Cord

Model#	Length
6570-36-*	36in (0.9m)

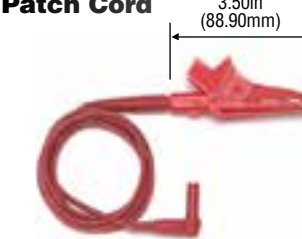

Alligator length: 3.6in (91.44mm),
Jaw Opening: 0.8in (20.32mm).
Rating: Conforms to IEC61010-031, Overvoltage. Category III, 1000V, 10A.
Cable: High flex 18 AWG Silicone wire.

*Std. Colors: -0 Black, -2 Red.

Minigrabber® Test Clip to Straight Banana Plug Patch Cord

Model#	Length
4650-24-*	24in (0.6m)
4650-36-*	36in (0.9m)



Hook attaches to component leads up to 0.060in (1.52mm) O.D.
Cable: 20 AWG Wire, 0.087in (2.21mm) O.D.
Rating: For CE compliance and for personal safety, do not hold in hand when voltages exceed 30 Vrms/42.4 Vpk/60 Vdc or current exceeds 8A maximum. Maximum voltage for *hands free use*: 300V. Do not use on circuits where transient stresses can exceed the rated voltage. 5A, +122°F (+50°C) max.

*Std. Colors: -0 Black, -2 Red.

**0.025in (0.64mm)
Square Pin Jack to
Straight Banana Plug**

Model#	Length
4771-24-*	24in (0.6m)
4771-36-*	36in (0.9m)



Cable: 22 AWG Wire, 0.064in (1.63mm) O.D.
Rating: For CE compliance and for personal safety, do not hold in hand when voltages exceed 30 Vrms/42.4 Vpk/60 Vdc or current exceeds 8A maximum. Maximum voltage for hands free use: 30 Vrms/42.4 Vpk/60 Vdc or current exceeds 8A maximum. Do not use on circuits where transient stresses can exceed the rated voltage. 3A, +122°F (+50°C) max.

*Std. Colors: -0 Black, -2 Red.

**0.025in (0.64mm)
Square Pin Jack
Patch Cord**

Model#	Length
4741-6-*	6in (0.15m)
4741-12-*	12in (0.3m)
4741-24-*	24in (0.6m)

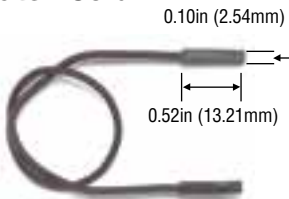

Cable: 22 AWG Wire, 0.064in (1.63mm) O.D.
Rating: For CE compliance and for personal safety, do not hold in hand when voltages exceed 30 Vrms/42.4 Vpk/60 Vdc or current exceeds 8A maximum. Maximum voltage for hands free use: 45 Vac/60 Vdc. Do not use on circuits where transient stresses can exceed the rated voltage. 3A, +122°F (+50°C) max.

*Std. Colors: -0 Black, -2 Red.

**0.025in (0.64mm)
Square Pin Jack
Patch Cord Kit**

Model# 5948

Kit contains 10 pcs. of Model 4741-6, one ea. of 10 colors.

**0.025in (0.64mm)
Square Pin Jack to
0.080in (2.03mm)
Pin Tip Plug**

Model#	Length
4772-24-*	24in (0.6m)



Cable: 22 AWG Wire, 0.064in (1.63mm) O.D.
Rating: For CE compliance and for personal safety, do not hold in hand when voltages exceed 30 Vrms/42.4 Vpk/60 Vdc or current exceeds 8A maximum. Maximum voltage for hands free use: 45 Vac/60 Vdc. Do not use on circuits where transient stresses can exceed the rated voltage. 3A, +122°F (+50°C) max.

*Std. Colors: -0 Black, -2 Red.

**Stacking Pin Tip Plug
Patch Cord**

Model#	Length
P-4-*	4in (0.1m)
P-8-*	8in (0.2m)
P-12-*	12in (0.3m)
P-18-*	18in (0.5m)
P-24-*	24in (0.6m)
P-36-*	36in (0.9m)

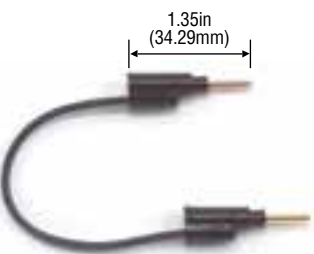

Cable: 20 AWG Wire, 0.087in (2.21mm) O.D.
Rating: For CE compliance and for personal safety, do not hold in hand when voltages exceed 30 Vrms/42.4 Vpk/60 Vdc or current exceeds 8A maximum. Maximum voltage for hands free use: 3000 Vdc. Do not use on circuits where transient stresses can exceed the rated voltage. 5A, +131°F (+55°C) max.

*Std. Colors: -0 Black, -2 Red.

**Banana Plug to
Banana Jack**

Model#	Length
4702-24-*	24in (0.6m)
4702-36-*	36in (0.9m)
4702-48-*	48in (1.2m)



Cable: 18 AWG Wire, 0.144in (3.56mm) O.D.

Rating: For CE compliance and for personal safety, do not hold in hand when voltages exceed 30 Vrms/42.4 Vpk/60 Vdc or current exceeds 8A maximum. Maximum voltage for hands free use: 5000 Vdc. Do not use on circuits where transient stresses can exceed the rated voltage. 15A, +131°F (+55°C) max.

*Std. Colors: -0 Black, -2 Red.

**Minigrabber® Test Clip
to Miniature Stacking
Banana Plug**

Model#	Length
3784-24-*	24in (0.6m)
3784-36-*	36in (0.9m)



Hook attaches to component leads up to 0.06in (1.52mm) O.D.

Cable: 20 AWG Wire, 0.087in (2.21mm) O.D.

Rating: For CE compliance and for personal safety, do not hold in hand when voltages exceed 30 Vrms/42.4 Vpk/60 Vdc or current exceeds 8A maximum. Maximum voltage for hands free use: 300V. Do not use on circuits where transient stresses can exceed the rated voltage. 5A, +131°F (+55°C) max.

*Std. Colors: -0 Black, -2 Red.

**Miniature Stacking
Banana Plug Patch Cord**

Model#	Length
1081-4-*	4in (0.1m)
1081-8-*	8in (0.2m)
1081-12-*	12in (0.3m)
1081-18-*	18in (0.5m)
1081-24-*	24in (0.6m)
1081-36-*	36in (0.9m)
1081-48-*	48in (1.2m)
1081-60-*	60in (1.5m)



Cable: 20 AWG Wire, 0.087in (2.21mm) O.D.

Rating: For CE compliance and for personal safety, do not hold in hand when voltages exceed 30 Vrms/42.4 Vpk/60 Vdc or current exceeds 8A maximum. Maximum voltage for hands free use: 3000 Vdc. Do not use on circuits where transient stresses can exceed the rated voltage. 5A, +131°F (+55°C) max.

*Std. Colors: -0 Black, -2 Red.

**Alligator Test Clip to
Insulated Spade Lug**

Model#	Length
1960-36-*	36in (0.9m)

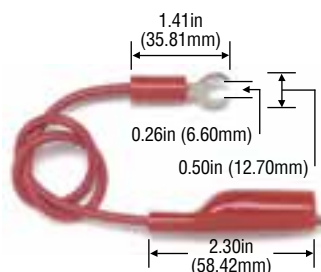

Jaw Opening: 0.30in (7.62mm).

Cable: 18 AWG Wire, 0.144in (3.56mm) O.D.

Rating: For CE compliance and for personal safety, do not hold in hand when voltages exceed 30 Vrms/42.4 Vpk/60 Vdc or current exceeds 8A maximum. Maximum voltage for hands free use: 150V. Do not use on circuits where transient stresses can exceed the rated voltage. 5A, +122°F (+50°C) max.

*Std. Colors: -0 Black, -2 Red.

*Color Code: -0 Black, -1 Brown, -2 Red, -3 Orange, -4 Yellow, -5 Green, -6 Blue, -7 Violet, -8 Gray, -9 White

Pomona has made it easy for you to have exactly what you need with a huge selection of patch cords and test leads designed for reliable, convenient connections. Whether you need a test lead that can access an IC pin without shorting or a patch cord that accommodates multiple stacking, Pomona Electronics' design and reliability are your connection with quality.

Calibration Accessory Kit

Model# CK73041

The Pomona CK73041 Calibration Kit includes the major connectors and test cables you need for instrument calibration in a comprehensive kit. Versatile adapters and flexible cables greatly expand the variety of test cables you can create, reducing the number of special-purpose patch cords and connectors needed for calibration applications.

Perfect for:

- Field Calibration
- Outfitting a new technician or lab
- Comprehensive replacement of important connectors and leads



The Calibration Kit allows you to:

- Combine connectors with patch cords to create a wide variety of necessary test cables.
- Reduce the number of test cables needed by creating multiple combinations.
- Make low voltage precision measurements with shielded low thermal EMF spade lug patch cords.
- Easily connect to a variety of test equipment with BNC to banana and BNC to binding post adapters.
- Use shielded coax cables for test and calibration rather than unshielded leads.
- Turn banana plug patch cords into test leads terminated with alligator clips, spade lugs, or pin tips.
- Access N Type instrument jacks.
- Connect to analog components from coaxial cables.
- Take advantage of shielded dual conductor patch cords.
- Daisy-chain leads for those long lead situations.

For data sheets / specifications of the individual components contained in the CK73041 Calibration Kit, please visit our Pomona website at: www.pomonaelectronics.com

