

FLUKE®

377/377 FC
378/378 FC
Clamp Meter

Users Manual

January 2021

©2021 Fluke Corporation. All rights reserved.

All product names are trademarks of their respective companies.

LIMITED WARRANTY AND LIMITATION OF LIABILITY

Each Fluke product is warranted to be free from defects in material and workmanship under normal use and service. The warranty period is three years and begins on the date of shipment. Parts, product repairs, and services are warranted for 90 days. This warranty extends only to the original buyer or end-user customer of a Fluke authorized reseller, and does not apply to fuses, disposable batteries, or to any product which, in Fluke's opinion, has been misused, altered, neglected, contaminated, or damaged by accident or abnormal conditions of operation or handling. Fluke warrants that software will operate substantially in accordance with its functional specifications for 90 days and that it has been properly recorded on non-defective media. Fluke does not warrant that software will be error free or operate without interruption.

Fluke authorized resellers shall extend this warranty on new and unused products to end-user customers only but have no authority to extend a greater or different warranty on behalf of Fluke. Warranty support is available only if product is purchased through a Fluke authorized sales outlet or Buyer has paid the applicable international price. Fluke reserves the right to invoice Buyer for importation costs of repair/replacement parts when product purchased in one country is submitted for repair in another country.

Fluke's warranty obligation is limited, at Fluke's option, to refund of the purchase price, free of charge repair, or replacement of a defective product which is returned to a Fluke authorized service center within the warranty period.

To obtain warranty service, contact your nearest Fluke authorized service center to obtain return authorization information, then send the product to that service center, with a description of the difficulty, postage and insurance prepaid (FOB Destination). Fluke assumes no risk for damage in transit. Following warranty repair, the product will be returned to Buyer, transportation prepaid (FOB Destination). If Fluke determines that failure was caused by neglect, misuse, contamination, alteration, accident, or abnormal condition of operation or handling, including overvoltage failures caused by use outside the product's specified rating, or normal wear and tear of mechanical components, Fluke will provide an estimate of repair costs and obtain authorization before commencing the work. Following repair, the product will be returned to the Buyer transportation prepaid and the Buyer will be billed for the repair and return transportation charges (FOB Shipping Point).

THIS WARRANTY IS BUYER'S SOLE AND EXCLUSIVE REMEDY AND IS IN LIEU OF ALL OTHER WARRANTIES, EXPRESS OR IMPLIED, INCLUDING BUT NOT LIMITED TO ANY IMPLIED WARRANTY OF MERCHANTABILITY OR FITNESS FOR A PARTICULAR PURPOSE. FLUKE SHALL NOT BE LIABLE FOR ANY SPECIAL, INDIRECT, INCIDENTAL OR CONSEQUENTIAL DAMAGES OR LOSSES, INCLUDING LOSS OF DATA, ARISING FROM ANY CAUSE OR THEORY.

Since some countries or states do not allow limitation of the term of an implied warranty, or exclusion or limitation of incidental or consequential damages, the limitations and exclusions of this warranty may not apply to every buyer. If any provision of this Warranty is held invalid or unenforceable by a court or other decision-maker of competent jurisdiction, such holding will not affect the validity or enforceability of any other provision.

Fluke Corporation
P.O. Box 9090
Everett, WA 98206-9090
U.S.A.

Fluke Europe B. V.
P.O. Box 1186
5602 BD Eindhoven
The Netherlands

Table of Contents

Title	Page
Introduction	1
Contact Fluke	2
Safety Information	2
Specifications	2
Before You Start	3
Terms to Know	5
Fluke Connect™ (377 FC/378 FC)	5
Radio Frequency Data	5
Fluke Connect™ Mobile App	5
Battery	6
Features/Controls	7
Display	8
Power	9
Auto Power Off	9
Backlight	9
Power-On Options	10
Basic Measurements	11
Hazardous Voltage Indicator	11
FieldSense™ Measurement	11
FieldSense AC Current, Voltage, and Frequency	11
L1-L2-L3	12
Power Quality Indicator (378/378 FC)	13

AC/DC Voltage Measurement with Test Leads	13
Resistance/Continuity	13
Capacitance	14
DC Current	14
iFlex Probe	14
Measurement Features	16
Display Hold	16
MIN/MAX/AVG Measurements	16
Inrush Current	16
Data Logging (377 FC/378 FC)	17
Clear Memory (377 FC/378 FC)	17
Firmware Update (377 FC/378 FC)	17
Firmware Version	17
Maintenance	18
How to Clean the Case	18
Environmental	18
Service	18

Introduction

The Fluke 377, 377 FC, 378, and 378 FC Current Clamp (the Clamp or Product) provides:

- display with two simultaneous measurements (current and voltage)
- grounding with a single lead
- live measurements with no circuit downtime
- non-contact voltage measurement with Power Quality Indicator
- wireless connectivity to smartphone for work-orders and reporting integration with Fluke Connect™ app

The Clamp measures true-rms ac current and voltage, dc current and voltage, inrush current, resistance, capacitance, frequency, and dc millivolts.

The included iFlex (detachable, flexible current-probe) expands the measurement range to 2500 A ac. The iFlex allows measurements of awkward sized conductors and improved wire access.

The illustrations in this manual show the 378 FC.

Table 1 is a list of features available for each model.

Table 1. Features by Model

Model	377	378	377 FC	378 FC
BLE for Fluke Connect™ App			•	•
Power Quality Indicator		•		•
Phase Rotation			Fluke Connect App Only	Fluke Connect App Only
Sequential phase: non-contact voltage measurement	•	•	•	•
Phase-to-phase voltage calculation	•	•	•	•
True RMS	•	•	•	•
Logging			•	•

Contact Fluke

Fluke Corporation operates worldwide. For local contact information, go to our website: www.fluke.com.

To register your product, view, print, or download the latest manual or manual supplement, go to our website.

Fluke Corporation
P.O. Box 9090
Everett, WA 98206-9090
+1-425-446-5500
fluke-info@fluke.com

Safety Information

General safety information is in the printed *Safety Information* document that ships with the Product and at www.fluke.com. More specific safety information is listed where applicable.

Specifications

Complete specifications are at www.fluke.com. See the *377/377 FC / 378/378 FC Product Specifications*.

Before You Start

Table 2 is a list of items included with the Product. Use Table 3 to order additional accessories.

Table 2. Standard Equipment

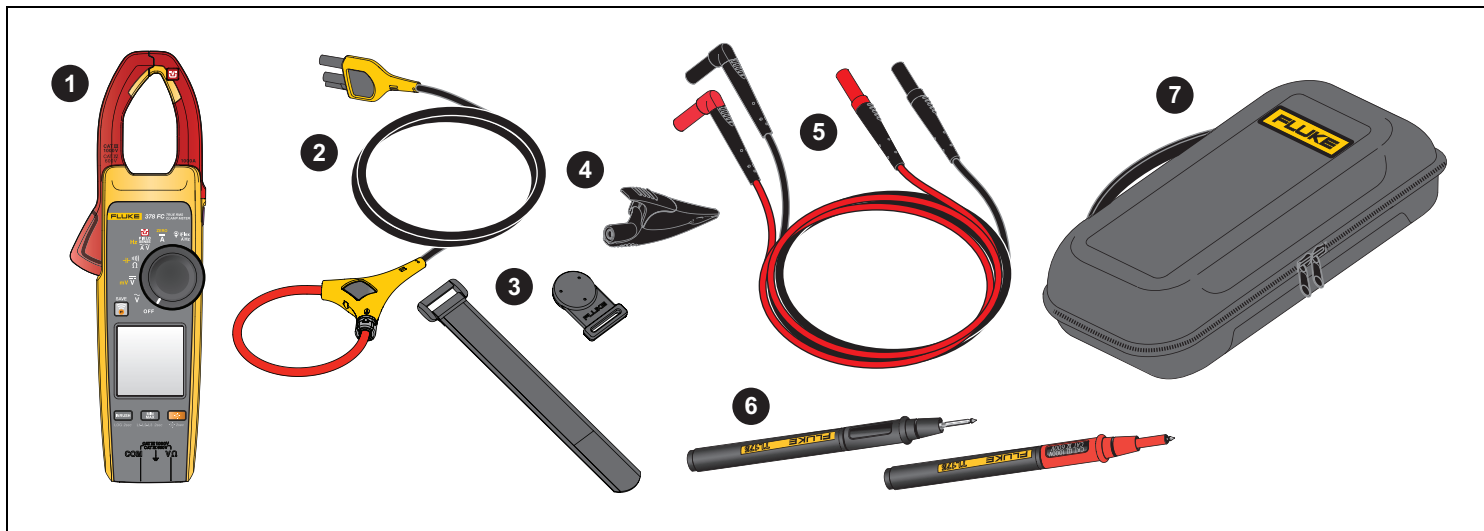

Item	Model Number	Description
1	varies	Clamp Meter
2	i2500-18 iFlex	Flexible Current Probe 18 in (48 cm)
3	TPAK	Hanging Kit
4	AC285	Alligator Clip (black)
5	TL224	Insulated Test Lead Set
6	TP175	Test Probe Set
7	37x	Carry Case

Table 3. Accessories

Model Number	Description
C550	Tool Bag
AC87	Heavy-Duty Bus Bar Clip Set (one pair: red and black)
AC89	Heavy-Duty Insulation Piercing Test Clip
TL27	Heavy Duty Test Lead Set
TL75	Hard Point Test Lead Set (one pair: red and black)

Terms to Know

Use this section to familiarize yourself with these terms that are unique to this Product.

FieldSense™ Technology/Non-contact voltage (NCV)

Measurement. Voltage measurements by capacitive sensing technology that completes galvanic isolation. This technology uses capacitive sensors for measuring AC voltages through non-galvanic contact, coupled with a Hall Effect jaw that allows simultaneous current measurements. It enables minimizing voltage probes connections, therefore reducing hazardous situations and saving setup-up time, and circuit or machine downtime. Fluke-developed icon for FieldSense technology is .

L1-L2-L3. L1, L2, and L3 (or Line 1, Line 2, and Line 3) is a common naming convention for the wires in three-phase alternating current (ac) systems. The Clamp features a sequential line-to-ground measurement that results in a calculated line-to-line voltage measurement. This voltage measurement is an indication that the three-phase system is, or is not, working as expected.

Power Factor. Power factor (PF) is the ratio of working power, measured in kilowatts (kW), to apparent power, measured in kilovolt amperes (kVA). PF expresses the ratio of true power used in a circuit to the apparent power delivered to the circuit.

Fluke Connect™ App. Fluke Connect is a system that wirelessly connects your Clamp with an app on your smartphone or tablet.

THD. The total harmonic distortion is a measurement of the harmonic distortion present in a signal and is defined as the ratio of the sum of the powers of all harmonic components to the power of the fundamental frequency.

Fluke Connect™ (377 FC/378 FC)

Fluke Connect™ software (may not be available in all regions) supports the Clamp to wirelessly connect to a mobile app. The app shows the measurements and other data on your smartphone or tablet display. You can share this data with your team and save collected measurements and calculations to the Fluke Connect Cloud.

Fluke Connect uses low-power 802.15.4 wireless radio technology to connect the Clamp with an app on your smartphone or tablet. The wireless radio does not cause interference with Clamp measurements.

Radio Frequency Data

Note

Changes or modifications to the wireless 2.4 GHz radio not expressly approved by Fluke Corporation could void the user's authority to operate the equipment.

For complete information about radio frequency data, go to www.fluke.com/manuals and search for "Radio Frequency Data Class A".



SIMPLIFIED EU DECLARATION OF CONFORMITY

Hereby, Fluke declares that the radio equipment contained in this Product is in compliance with Directive 2014/53/EU. The full text of the EU declaration is available at the following internet address: www.fluke.com/declaration-of-conformity

Fluke Connect™ Mobile App

The Fluke Connect™ app works with Apple and Android mobile products. The app is available for download to your smart device from the Apple App Store and Google Play.

To use the Fluke Connect app:

1. Open the Fluke Connect app on your device.
2. Turn on the Clamp.
3. Push  to activate the radio on the Clamp.  shows on the display.
4. On your smartphone, go to **Settings > Bluetooth**.
5. Verify that Bluetooth is turned on.
6. Go to the Fluke Connect App and in the list of connected Fluke tools, select **377 FC/378 FC**.

You can now take, save, and share measurements with the app. Go to www.flukeconnect.com for more information about how to use the app.

Battery

⚠⚠ Warning

To prevent personal injury and for safe operation of the Product:

- The battery door must be closed and locked before you operate the Product.
- Remove all probes, test leads, and accessories before the battery door is opened.
- Replace the batteries when the low battery indicator shows to prevent incorrect measurements.
- When batteries are changed, ensure that the calibration seal in the battery compartment is not damaged. If damaged, the Product may not be safe to use. Return the Product to Fluke for replacement of the seal.

⚠ Caution

To prevent damage to the battery:

- Repair the Product before use if the battery leaks.
- Do not expose battery to heat sources or high-temperature environments such as an unattended vehicle in the sun.
- Always operate in the specified temperature range.
- Do not incinerate the Product and/or battery.

The Product ships with the batteries installed. To replace batteries, see Figure 1.



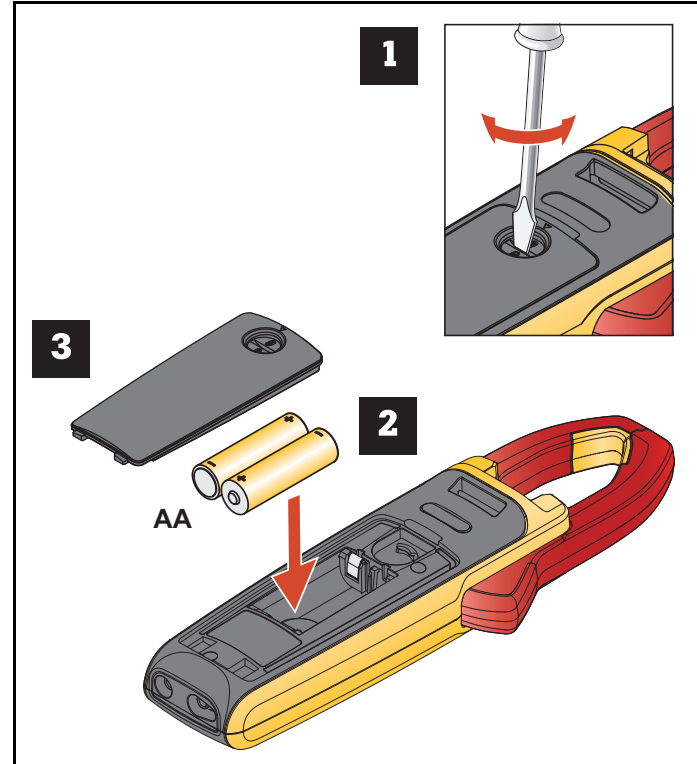





Figure 1. Batteries



Features/Controls

Table 4 is a list of features and controls.

Table 4. Feature/Control Descriptions

	Item	Description
	1	Jaw with FieldSense™ technology 
	2	Tactile Barrier
	3	Hold
	4	Control Knob
	5	Display
	6	377/378:  turn on/turn off the backlight. 377 FC/378 FC:  extends the function selection to yellow items on the control knob. Push >2 s. to turn on/turn off the backlight.
	7	Volts/Ohm input terminal
	8	Common terminal
	9	Min/Max/Avg for current, voltage, and frequency measurement functions. Push >2 s. to turn on/turn off the L1-L2-L3 measurement function.
	10	INRUSH: push to enter inrush mode. Push a second time to exit inrush mode. Integration time is 100 ms. Push >2 s. to start data logging function with the Fluke Connect mobile app.
	11	377/378:  extends the function selection to yellow items on the control knob. 377 FC/378 FC:  turn on the Fluke Connect feature.  turns blue and flashes when paired with the Fluke Connect mobile phone app. When on, push  to save a measurement to the Fluke Connect mobile app. Push  >2 s. to turn off the Fluke Connect feature.
	12	Jaw release

Display

Table 5 is a list of the display annunciators.

Table 5. Display

Item	Description
1	Clamp senses a voltage ± 30 V or a voltage overload (OL)
2	L1, L2, L3 mode is active
3	FieldSense™ measurement requires a ground connection
4	Line-to-line measurement
5	Jaw measurement
6	iFlex measurement
7	Fluke Connect feature is on
8	FieldSense™ measurement
9	Remaining memory (377 FC/378 FC)
10	Inrush measurement
11	Log mode is active (377 FC/378 FC)
12	Hold mode is active
13	MinMax mode is active
14	Battery status
15	Min, Max, or Avg measurement indication
16	Continuity indication
17	Power Quality indication: PQ-Amps PQ-Volts PQ-PF
18	Current measurement
19	Line-to-line calculation
20	Voltage/resistance/capacitance/frequency measurement

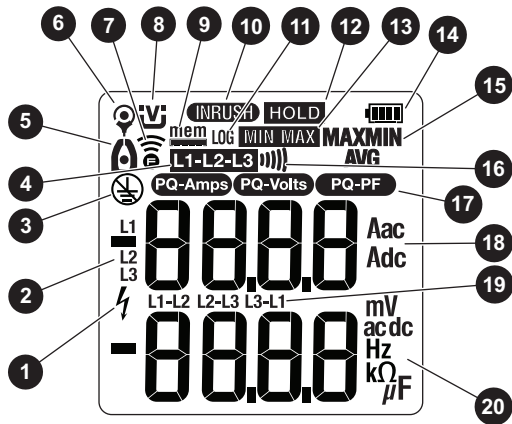

Power

Two AA batteries supply power to the Clamp:

- To turn on the Clamp, rotate the control knob to a function.
- To turn off the Clamp, rotate the control knob to **OFF**.

Auto Power Off

The Clamp automatically powers off after 20 minutes of no use. If the Clamp automatically powers off, turn the control knob to **OFF** and then to a function to resume operation.

To disable auto power off, see [Power-On Options](#).



Note

Auto power off is always disabled when you use the Min/Max/Avg function.

Backlight

The display on the Clamp includes a backlight that improves the readability in dim work areas.

FC models:

- Hold  for >2 seconds to turn on the backlight.
- Hold  for >2 seconds to turn off the backlight.

Non-FC models:

- Push  to toggle on/toggle off the backlight.

The backlight has an auto off feature that turns off the backlight after 2 minutes of no use. To disable the auto off backlight feature, see [Power-On Options](#).

Power-On Options

Power-on options allow you to customize the controls:

- Turn off/turn on audible beeper
- Turn off/turn on auto backlight
- Turn on/turn off auto power shutoff
- Clear Logging Memory
- Set PQ Sensitivity Level

To select a power-on option:

1. Turn off the Clamp.
2. Push and hold **HOLD** as you turn the control knob to \tilde{V} .

The Clamp goes into the option mode.

Note

*Anytime you release **HOLD** the Clamp exits the option mode but retains any changes to the settings.*

3. Push to go through the options.

4. Push to change a setting.

Option	Display
Beeper Enabled	bEEP On
Beeper Disabled	bEEP OFF
Auto Backlight On (Backlight turns off after 2 minutes of no use)	BCLt On
Auto Backlight Off (Backlight stays on)	BCLt OFF
Auto Power On (Clamp powers off after 20 minutes of no use)	AUtO On
Auto Power Off (Auto Power Off is disabled)	AUtO OFF
Clear Logging Memory	CLr
PQ Sensitivity	LEU H LEU n r Ed LEU LO

5. Release **HOLD** to exit the options mode.

All power-on options are canceled when you turn off the Clamp with the exception of PQ Sensitivity setting.

Basic Measurements

⚠⚠ Warning

To prevent possible electrical shock, fire, or personal injury:

- Hold the Product behind the tactile barrier.
- Do not measure current while the test leads are in the input jacks.

Note

Exposure to severe mechanical shock may cause the readings of the Product to not meet the specifications. If the published accuracy is required, the Product should be calibrated to verify proper operation after such an event. See [Service](#).

Hazardous Voltage Indicator

When the Clamp senses a voltage ± 30 V or a voltage overload (OL), ⚡ shows on the display to tell you a hazardous voltage is at the Clamp input.

FieldSense™ Measurement

FieldSense measurement, or non-contact voltage (NCV) measurement, is ac voltage, current, and frequency measurement with no electrical contact to live voltage. The Clamp display shows the voltage and current measurements at the same time.

Note

All FieldSense measurements require a ground lead connection.

FieldSense AC Current, Voltage, and Frequency

To make the measurement:

1. Insert the ground lead into the COM input and attach the alligator clip to ground.
2. Rotate the control knob to V .

The display shows the V icon.

3. Use the jaw release to open the jaw and position the Clamp around the conductor. Close the jaw and make sure the wire position is correct. See Figure 2.

Figure 2. Wire Placement

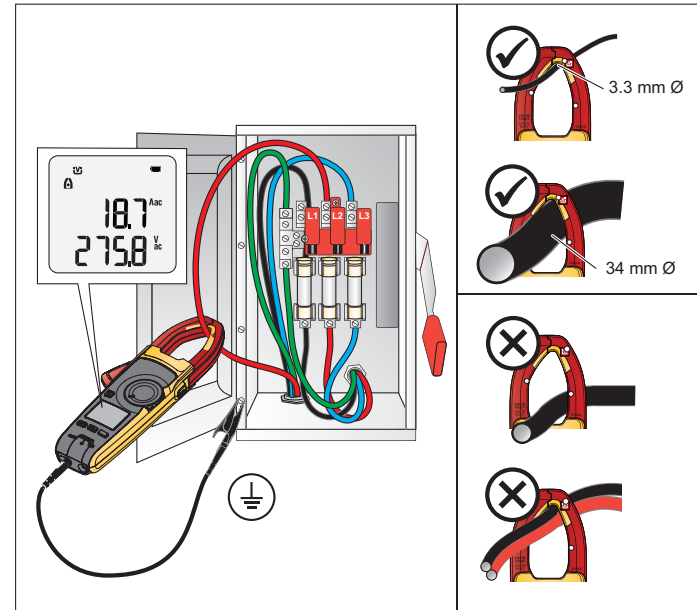

The display shows A to indicate that the measurement is from the jaw. When the current measurement is < 0.5 A, the center dot in the icon flashes. For current measurements > 0.5 A, the center dot in the icon is steady. The **Aac** display shows - - - when a measurement is < 1 A.

Note

Use V to toggle on/toggle off the **Amps Hz** function shown in yellow at the control knob position.



FieldSense technology is not intended to measure the output of a variable-frequency drive (VFD) motor controller. Use the V or $\text{IFlex}_{\text{AHz}}$ control knob position for this application.

L1-L2-L3

Three-phase alternating current (ac) systems are universally used to distribute electrical power and to supply electricity directly to high-power equipment. Use the Clamp to make sequential line-to-ground measurements that result in calculated line-to-line voltage measurements. These voltage measurements are an indication that the three-phase system is, or is not, working as expected.

When you use the Fluke Connect mobile app, the Clamp also indicates the phase rotation as 1-2-3 or 3-2-1 in the three-phase system.



To setup:

1. Turn the control knob to .
2. Connect the Clamp to ground with the ground lead.
3. Push  for >2 seconds. The Clamp is in the line-to-line mode and **L1-L2-L3** shows on the display.



To test:

1. Position the Clamp jaw around the first conductor.
Wait for the measurement on the display to settle. You will hear a beep and **L1** shows on the display.
2. Move the Clamp jaw to the second conductor within 10 seconds.
Wait for the measurement on the display to settle. You will hear a beep and **L2** shows on the display.
3. Move the Clamp jaw to the next conductor within 10 seconds.
Wait for the measurement on the display to settle. You will hear a beep and **L3** shows on the display.

When the **L1-L2-L3** measurements are complete, use the Clamp to calculate the total voltage between each pair of conductors:

1. Push . The display shows the total voltage between **L1** and **L2**.
2. Push  again to show the total voltage between **L2** and **L3**.
3. Push  again to show the total voltage between **L3** and **L1**.

While in the line-to-line mode, you can review each line-to-ground measurement:

1. Push  again to show the **L1** measurement.
2. Push  again to show the **L2** measurement.
3. Push  again to show the **L3** measurement.

To review L1-L2-L3 measurements, continue to push  and scroll through the measurements.

To exit the line-to-line mode, push  for >2 seconds.

Power Quality Indicator (378/378 FC)

The Power Quality indicator shows that the ratio of the real power compared to the apparent power or harmonic distortion is outside the optimal range.

To setup:

1. Turn the control knob to .
2. Connect the Clamp to ground with the ground lead.

If the total harmonic distortion or the power factor is outside the optimal range, the related indicator shows on the display:







Fluke Connect software supports the Power Quality indicator.

The Power Quality indicator sensitivity is adjustable:

Function	Sensitivity		
	High	Medium	Low
PQ-Amps	10 % THD	25 % THD	50 % THD
PQ-Volts	8 % THD	10 % THD	15 % THD
PQ-PF	0.9	0.75	0.6

For information about how to set the sensitivity, see [Power-On Options](#).

AC/DC Voltage Measurement with Test Leads

To measure ac or dc voltage:

1. Turn control knob to \tilde{V} or $mV\bar{V}$.
2. Connect the black test lead to the **COM** terminal and the red test lead to the **V Ω** terminal.
3. Touch the probes to the test points of the circuit.

The display shows the measurement.

Note

Use  to toggle on/toggle off the **mV** function shown in yellow at the control knob position.

Resistance/Continuity

To measure resistance or continuity:

1. Turn the control knob to $\frac{\ast}{\Omega}$.
2. Remove power from the circuit to test.
3. Connect the black test lead to the **COM** terminal and the red test lead to the **V Ω** terminal.
4. Touch the probes to the test points of the circuit.

The display shows the measurement.

If the resistance is $<30\ \Omega$, the beeper sounds continuously to indicate continuity. If the display shows **OL**, the circuit is open.

To disable the beeper, see [Power-On Options](#).

Capacitance

The Clamp determines capacitance by charging a capacitor with a known current, measuring the resulting voltage, then calculating the capacitance.



Note

A good capacitor stores an electrical charge and may remain energized after power is removed. Before you touch the capacitor or make a measurement, turn all power OFF, use the Clamp to confirm that power is OFF, and carefully discharge the capacitor by connecting a resistor across the leads. Be sure to wear appropriate personal protective equipment.

To test capacitance:

1. Turn the control knob to $\frac{\mu}{\Omega}$.
2. Push  to shift to the $\frac{\mu}{\Omega}$ function.
3. Remove the capacitor from the circuit and discharge the capacitor.
4. Connect the black test lead to the **COM** terminal and the red test lead to the **V Ω** terminal.
5. Touch the probes to the capacitor leads.

The display shows the measurement.

 indicates the capacitor is faulty or the capacitance value is higher than the measurement range.  indicates the capacitor does not properly discharge.

DC Current

To measure dc current:

1. Turn control knob to $\frac{\text{ZERO}}{\text{A}}$.
2. Push  to compensate for outside influences.

The display shows  to indicate that the measurement is from the jaw. When the current measurement is <0.5 A, the center dot in the icon flashes. For current measurements >0.5 A, the center dot in the icon is steady.

iFlex Probe

Warning

To avoid electrical shock, do not apply or remove from live hazardous conductors.

The high-performance AC Flexible Current Probe uses the Rogowski principle for accurate, non-intrusive measurement of sinusoidal, pulsed, and other complex waveforms. The flexible and lightweight measuring head allows quick and easy installation in hard-to-reach areas and works well with large conductors.

To use the iFlex Probe:

1. Connect the iFlex Probe to the Clamp. See Figure 3.
2. Connect the flexible part of the iFlex Probe around the conductor. If you open the end of the iFlex Probe to make the connection, make sure that you close and latch the coupling. See the detail in Figure 3. You should be able to hear and feel the lock snap into place.

Note

When you measure current, center the conductor in the iFlex Probe. Avoid measurements close to other current-carrying conductors.

3. Keep the probe coupling >2.5 cm (1 inch) away from the conductor.
4. Turn the control knob to  $\frac{\text{iFlex}}{\text{A Hz}}$.

The display shows  to indicate that the measurements are from the iFlex Probe. When the current measurement is <0.5 A, the center dot in the icon flashes. For current measurements >0.5 A, the center dot is steady.

The display shows the measurement.

If the iFlex Probe does not work as expected:

- Make sure that the coupling system is connected and closed correctly or look for any damage. If any foreign material is present, the coupling system will not close properly.
- Inspect the cable between the iFlex Probe and the Clamp for any damage.
- Check that the control knob is in the correct position  $\frac{\text{iFlex}}{\text{A Hz}}$.

Figure 3. iFlex Probe Setup



Measurement Features

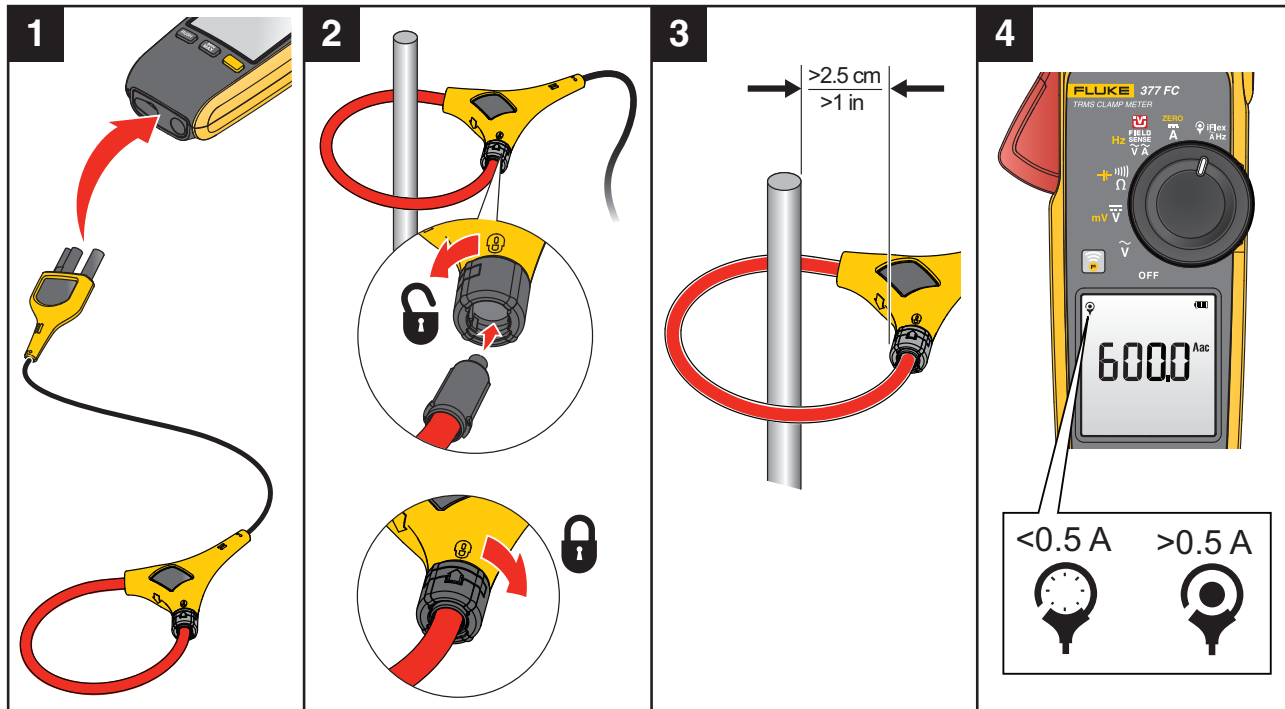

This section is about the Clamp features you can use for measurements.

Warning

To prevent possible electrical shock, fire, or personal injury:

- **Do not use the HOLD function to measure unknown potentials. When HOLD is turned on, the display does not change when a different potential is measured.**
- **Disconnect power and discharge all high-voltage capacitors before you measure resistance, continuity, capacitance, or a diode junction.**

Display Hold





To capture and hold the display reading, push . The display freezes and blinks **HOLD**. The Clamp periodically beeps to remind you that the measurement is not live. When in HOLD mode, if the Clamp senses a voltage ± 30 V or a voltage overload (OL),  shows on the display to tell you a hazardous voltage is at the Clamp input.

When in HOLD mode, push  again to resume normal operation with live readings.

MIN/MAX/AVG Measurements

Min Max Avg mode captures the minimum, maximum, and average readings of a given output signal over an extended time. The Clamp beeps when it senses a new high value or new low value.

This function works in current, voltage, and frequency modes:

1. Push  to enter the Min/Max/Avg mode.
The maximum reading shows on the display.
2. Continue to push  to select between the maximum, minimum, average, and live readings.
The cycle continues each time you push .
3. To exit Min/Max/Avg mode, push and hold  for >2 s.

Note

Auto Power Off is always disabled when you use the Min Max Avg function.

Inrush Current

Inrush Current is surge current that occurs when an electrical device is first powered on. The Clamp can capture this surge current reading. Current spikes from motor drives are one example of such an event. The Inrush function takes samples over a 100 ms period and calculates the starting current envelope.

To measure inrush current:

1. Select the measurement function (ac current, dc current, or iFlex ac current).
2. Center the Jaw or iFlex Probe around the live wire on the device.
3. Push .

Dashes show on the display until the Clamp detects the inrush current. When the inrush current is detected, the measurement shows on the display.

Data Logging (377 FC/378 FC)

The Fluke Connect™ app enables you to log the data measurements. This app shows measurements from the connected Clamp on your smartphone or tablet display. The app also saves the measurements to the Fluke Connect Cloud™ storage and shares the information with your team.

Note

The logging interval is set in the Fluke Connect app. Logging is not available for the inrush and line-to-line measurement modes.

To log measurements:

1. On the Clamp, push  for >2 s.

The memory icon indicates how much memory is available.

2. On the Clamp, push  for >2 s to stop logging.

Clear Memory (377 FC/378 FC)

See [Power-On Options](#).

Firmware Update (377 FC/378 FC)

Firmware updates are available for Clamps that have the Fluke Connect™ feature. The Fluke Connect mobile app shows a notification if a firmware update is available when the unit is connected to the app.







To update:

1. Make sure the Product has at least 50 % battery power available.
2. Make sure you download all the logged data before you update the firmware.
3. In the app, tap **Update** to start the firmware update to the Product.

Firmware Version

The firmware version for the Clamp is found in the Maintenance Mode.

To enter Maintenance Mode:

1. Turn off the Clamp.
2. Push and hold  as you turn the control knob to \tilde{V} .
The Clamp goes into the option mode.
3. Push  until  shows on the display.
4. Push .
5. Release .
6. Press  again to show the firmware version.

Maintenance

The Product does not require routine maintenance.

Warning

To prevent possible electrical shock, fire, or personal injury:

- Remove the input signals before you clean the Product.
- Repair the Product before use if the battery leaks. Battery leakage may create a shock hazard or damage the Product.
- Use only specified replacement parts.
- Have an approved technician repair the Product.
- Remove the batteries if the Product is not used for an extended period of time, or if stored in temperatures above 50 °C. If the batteries are not removed, battery leakage may result.

How to Clean the Case

Wipe the case with a damp cloth and mild detergent.

Caution

Do not use abrasives, isopropyl alcohol, or solvents to clean the case or lens/window.

Environmental

This Product has electronic printed circuit boards. These components must be disposed of specifically when the Product is at the end of its use.

The manufacturer offers to take back the Product from the customer to ensure that the Product is disposed of in an environmentally-friendly manner when it is at the end of its use.

See [Contact Fluke](#) for more information.

Service

An authorized Fluke Calibration service center should service the Product at two-year intervals to maintain optimum performance.

Contact your equipment distributor or authorized Fluke Calibration Service Center for any equipment performance failure or to schedule regular maintenance service. See [Contact Fluke](#) for more information.

Table 6 is a list of replacement parts.

Table 6. Replacement Parts

Item/Description	Fluke Part or Model Number
Battery, AA 1.5 V (x2)	376756
Battery Door	5105034
Insulated Test Lead Set	TL224
Test Probe Set	TP175
Alligator Clip	AC285
Flexible Current Probe i2500-10	3676410
Flexible Current Probe i2500-18	3798105
Magnet Strap	669952
Strap (9-inch)	669960
Carry Case	5211830