

**FLUKE**®

# 59 MAX/59 MAX +

Infrared Thermometer

**Users Manual**

PN 4311999

March 2013

© 2013 Fluke Corporation. All rights reserved.

Specifications are subject to change without notice.

All product names are trademarks of their respective companies.

## **LIMITED WARRANTY AND LIMITATION OF LIABILITY**

This Fluke product will be free from defects in material and workmanship for one year from the date of purchase. This warranty does not cover fuses, disposable batteries, or damage from accident, neglect, misuse, alteration, contamination, or abnormal conditions of operation or handling. Resellers are not authorized to extend any other warranty on Fluke's behalf. To obtain service during the warranty period, contact your nearest Fluke authorized service center to obtain return authorization information, then send the product to that Service Center with a description of the problem.

**THIS WARRANTY IS YOUR ONLY REMEDY. NO OTHER WARRANTIES, SUCH AS FITNESS FOR A PARTICULAR PURPOSE, ARE EXPRESSED OR IMPLIED. FLUKE IS NOT LIABLE FOR ANY SPECIAL, INDIRECT, INCIDENTAL OR CONSEQUENTIAL DAMAGES OR LOSSES, ARISING FROM ANY CAUSE OR THEORY.** Since some states or countries do not allow the exclusion or limitation of an implied warranty or of incidental or consequential damages, this limitation of liability may not apply to you.

Fluke Corporation  
P.O. Box 9090  
Everett, WA 98206-9090  
U.S.A.

Fluke Europe B.V.  
P.O. Box 1186  
5602 BD Eindhoven  
The Netherlands

# Table of Contents

Title	Page
Introduction.....	1
How to Contact Fluke .....	1
Safety Information .....	2
Maintenance .....	5
How to Change the Battery .....	5
How to Clean the Product .....	5
Specifications .....	6
Standards and Agency Approval.....	8
Nominal Surface Emissivity.....	9
The Product.....	10



## ***Introduction***

The Fluke 59 MAX and 59 MAX + Infrared Thermometers (the Product) can determine the surface temperature by measuring the amount of infrared energy radiated by the target's surface.

### **Warning**

**Read all safety information before you use the Product.**

## ***How to Contact Fluke***

To contact Fluke, call one of the following telephone numbers:

- Technical Support USA: 1-800-44-FLUKE (1-800-443-5853)
- Calibration/Repair USA: 1-888-99-FLUKE (1-888-993-5853)
- Canada: 1-800-36-FLUKE (1-800-363-5853)
- Europe: +31 402-675-200
- Japan: +81-03-6714-3114
- Singapore: +65-6799-5566
- Anywhere in the world: +1-425-446-5500

Or, visit Fluke's website at [www.fluke.com](http://www.fluke.com).

To register your product, visit <http://register.fluke.com>.

To see, print, or download the latest manual supplement, visit <http://us.fluke.com/usen/support/manuals>.

## ***Safety Information***

A **Warning** identifies conditions and procedures that are dangerous to the user. A **Caution** identifies conditions and procedures that can cause damage to the Product or the equipment under test.

Table 1 tells you about symbols used on the Product and in this manual.







### **Warning**

**To prevent possible electrical shock, fire, or personal injury:**

- **Read all safety Information before you use the Product.**
- **Do not use the Product if it operates incorrectly.**
- **Use the Product only as specified, or the protection supplied by the Product can be compromised.**
- **Examine the case before you use the Product. Look for cracks or missing plastic. Carefully look at the insulation around the terminals.**

- **See emissivity information for actual temperatures. Reflective objects result in lower than actual temperature measurements. These objects pose a burn hazard.**
- **Do not look directly into the laser with optical tools (for example, binoculars, telescopes, microscopes). Optical tools can focus the laser and be dangerous to the eye.**
- **Do not look into the laser. Do not point laser directly at persons or animals or indirectly off reflective surfaces.**
- **Replace the batteries when the low battery indicator shows to prevent incorrect measurements.**
- **Do not use the Product around explosive gas, vapor, or in damp or wet environments.**
- **Use the Product only as specified or hazardous laser radiation exposure can occur.**
- **Carefully read all instructions.**

**Table 1. Symbols**

<b>Symbol</b>	<b>Meaning</b>	<b>Symbol</b>	<b>Meaning</b>
	Risk of danger. Important information. See Manual.		Conforms to relevant North American Safety Standards.
	Warning. Laser.		Conforms to European Union directives.
	Battery		Conforms to relevant Australian standards.
	This product complies with the WEEE Directive (2002/96/EC) marking requirements. The affixed label indicates that you must not discard this electrical/electronic product in domestic household waste. Product Category: With reference to the equipment types in the WEEE Directive Annex I, this product is classed as category 9 "Monitoring and Control Instrumentation" product. Do not dispose of this product as unsorted municipal waste. Go to Fluke's website for recycling information.		



## ***Maintenance***

### **Warning**

To prevent possible electrical shock, fire, or personal injury, have an approved technician repair the Product.

### **Caution**

To avoid damage to the Product, do not leave the thermometer on or near objects of high temperature.

#### ***How to Change the Battery***

To install or change the AA IEC LR06 battery, open the battery compartment and replace the battery as shown in Figure 16.

#### ***How to Clean the Product***

Use soap and water on a damp sponge or soft cloth to clean the Product case. Carefully wipe the surface with a moist cotton swab. The swab may be moistened with water. See Figure 17.

## **Specifications**

	<b>59 MAX</b>	<b>59 MAX +</b>
Temperature Range	-30 °C to 350 °C (-22 °F to 662 °F)	-30 °C to 500 °C (-22 °F to 932 °F)
Accuracy (Calibration geometry with ambient temperature 23 °C ±2 °C)	<p>≥0 °C: ±2.0 °C or ±2.0 % of reading, whichever is greater (≥32 °F: ±4.0 °F or ±2.0 % of reading, whichever is greater)</p> <p>≥ -10 °C to &lt;0 °C: ±2.0 °C (≥14 °F to &lt;32 °F: ±4.0 °F)</p> <p>&lt; -10 °C: ±3.0 °C (&lt;14 °F: ±6.0 °F)</p>	<p>≥0 °C: ±1.5 °C or ±1.5 % of reading, whichever is greater (≥32 °F: ±3.0 °F or ±1.5 % of reading, whichever is greater)</p> <p>≥ -10 °C to &lt;0 °C: ±2.0 °C (≥14 °F to &lt;32 °F: ±4.0 °F)</p> <p>&lt; -10 °C: ±3 °C (&lt;14 °F: ±6.0 °F)</p>
Response Time (95 %)	<500 ms (95 % of reading)	<500 ms (95 % of reading)
Spectral Response	8 μm to 14 μm	
Emissivity	0.10 to 1.00	

## ***Infrared Thermometer***

Optical Resolution	8:1 (calculated at 90 % energy)	10:1 (calculated at 90 % energy)
Display Resolution	0.1 °C (0.2 °F)	
Repeatability (% of reading)	±1.0 % of reading or ±1.0 °C (±2.0 °F), whichever is greater	±0.8 % of reading or ±1.0 °C (±2.0 °F), whichever is greater
Power	1 AA IEC LR06 Battery	
Battery Life	12 hours with laser and backlight on	
Weight	220 g (7.76 oz)	
Size	(156 x 80 x 50) mm (6.14 x 3.15 x 2) inches	
Operating Temperature	0 °C to 50 °C (32 °F to 122 °F)	
Storage Temperature	-20 °C to +60 °C (-4 °F to 140 °F), (without battery)	
Operating Humidity	10 % to 90 % RH non-condensing @ 30 °C (86 °F)	
Operating Altitude	2000 meters above mean sea level	
Storage Altitude	12,000 meters above mean sea level	
Drop Test	1 m	

## ***Standards and Agency Approval***

Ingress Protection Rating.....	IP40 per IEC 60529
Vibration and Shock.....	IEC 68-2-6 2.5 g, 10 to 200 Hz, IEC 68-2-27, 50 g, 11 ms
Compliance .....	EN/IEC 61010-1
Laser Safety .....	FDA and EN 60825-1 Class II
Electromagnetic Compatibility.....	61326-1 EN 61326-2

## Nominal Surface Emissivity

Material	Value	Material	Value
Default****	0.95	Glass (plate)	0.85
Aluminum*	0.30	Iron*	0.70
Asbestos	0.95	Lead*	0.50
Asphalt	0.95	Oil	0.94
Brass*	0.50	Paint	0.93
Ceramic	0.95	Plastic**	0.95
Concrete	0.95	Rubber	0.95
Copper*	0.60	Sand	0.90
Food - Frozen	0.90	Steel*	0.80
Food - Hot	0.93	Water	0.93
		Wood ***	0.94
<p>* Oxidized  ** Opaque, over 20 mils  *** Natural  **** Factory Setting  Highlighted items may also be found in the emissivity table built into the Thermometer.</p>			

## The Product

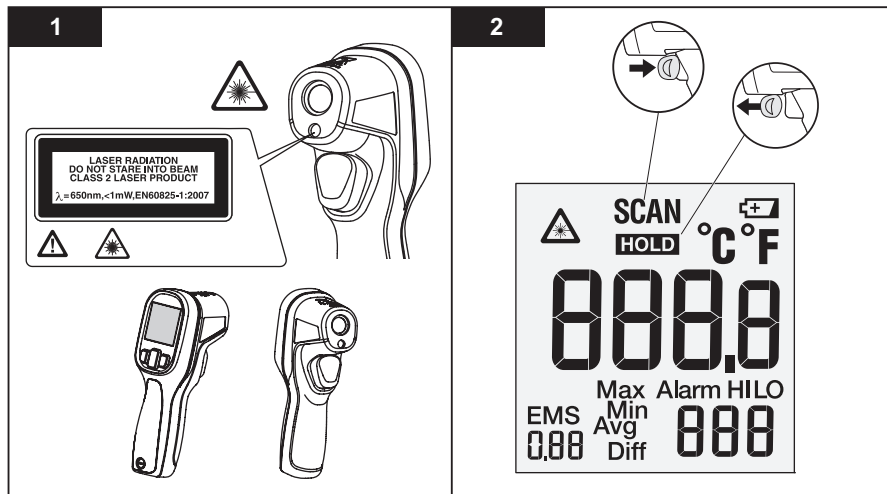

**3**



L i t E

On

SET

L i t E

OFF

**4**

°F/°C

°F

SET

°C

**5**

EMS

EMS  
0,88



EMS  
0,98



EMS  
0,58

**5**



L A S

On

SET

L A S

OFF

**6**

**Max/Min/Avg/Diff**

△ SCAN °F	△ SCAN °F	△ SCAN °F	△ SCAN °F
68,0	68,0	68,0	68,0
EMS Max 0,95 90	EMS Min 0,95 68	EMS Avg 0,95 76	EMS Diff 0,95 22
SEL	SEL	SEL	SEL

7

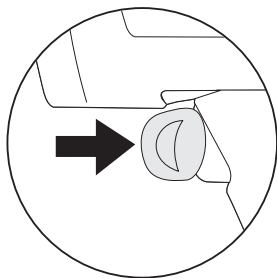
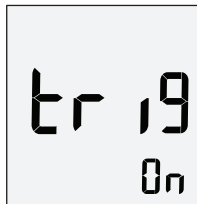

+

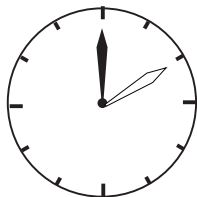

=

10 min

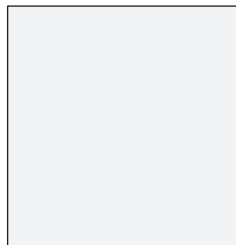

OFF



# Infrared Thermometer

## The Product

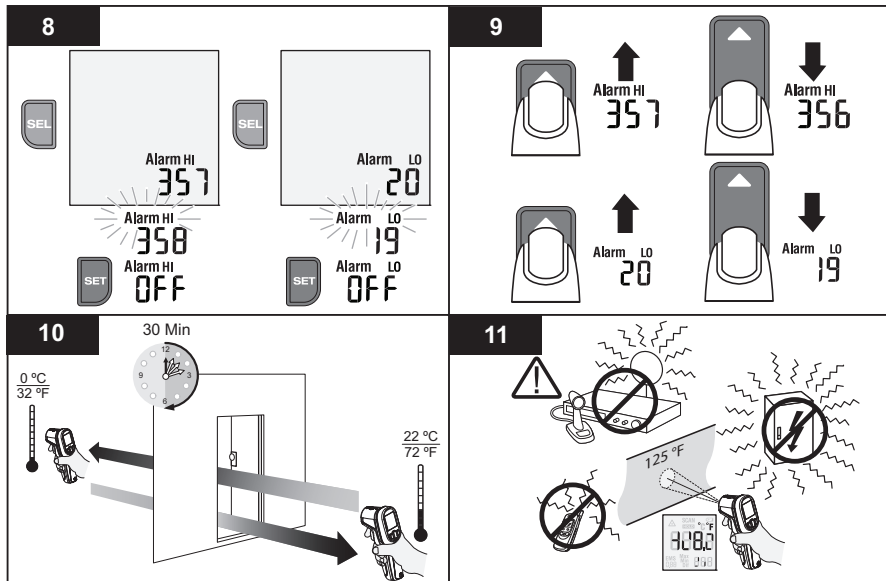

hdi15.eps

**59 MAX/59 MAX +**  
*Users Manual*

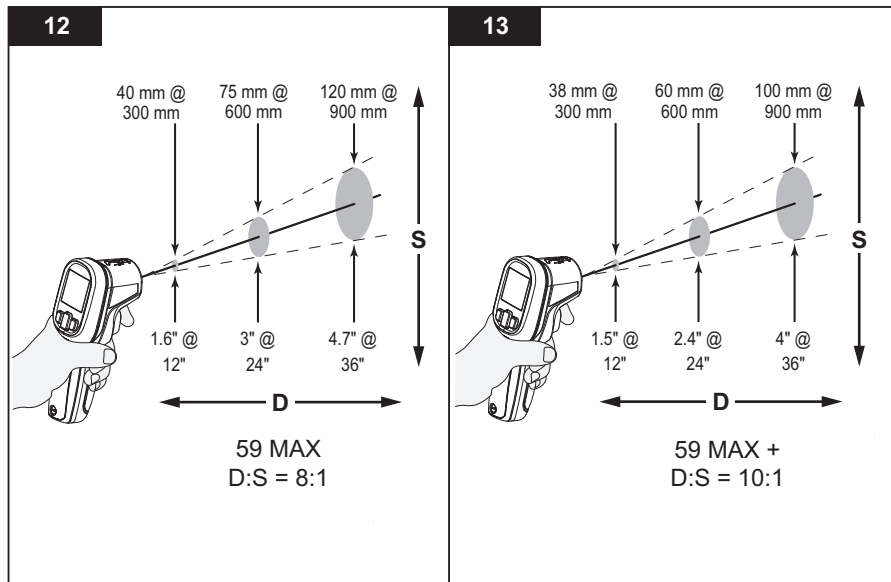

hdi08.eps

# Infrared Thermometer

## The Product

14

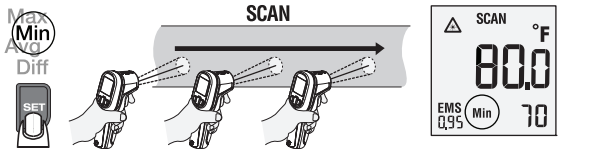
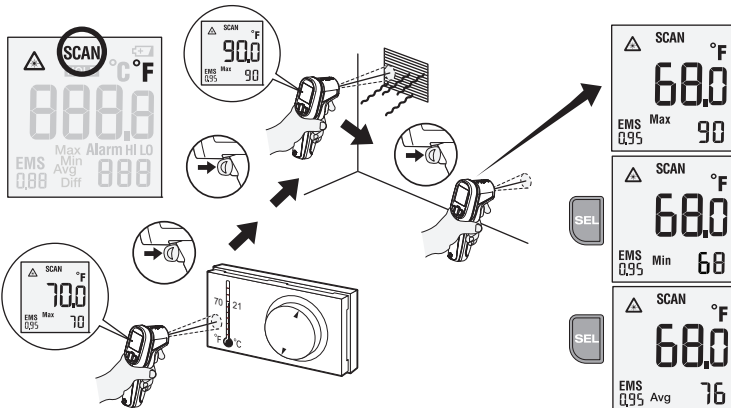

SEL

SEL

SEL

hdi03.eps

15

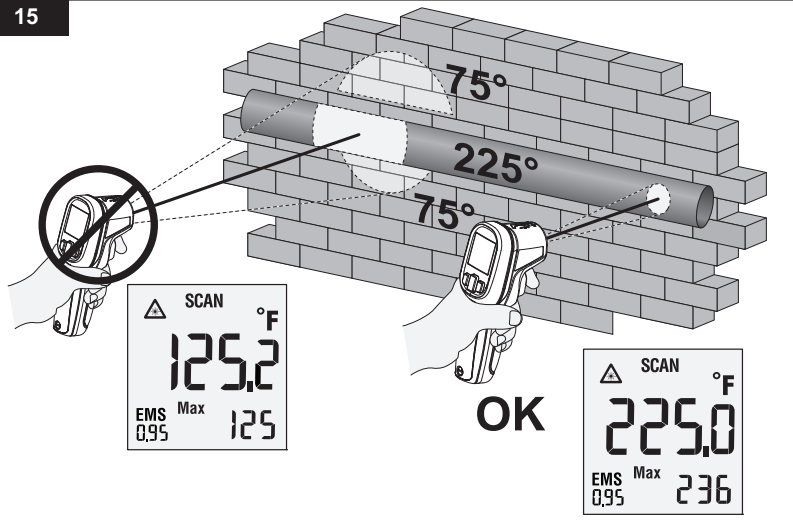

hdi04.eps

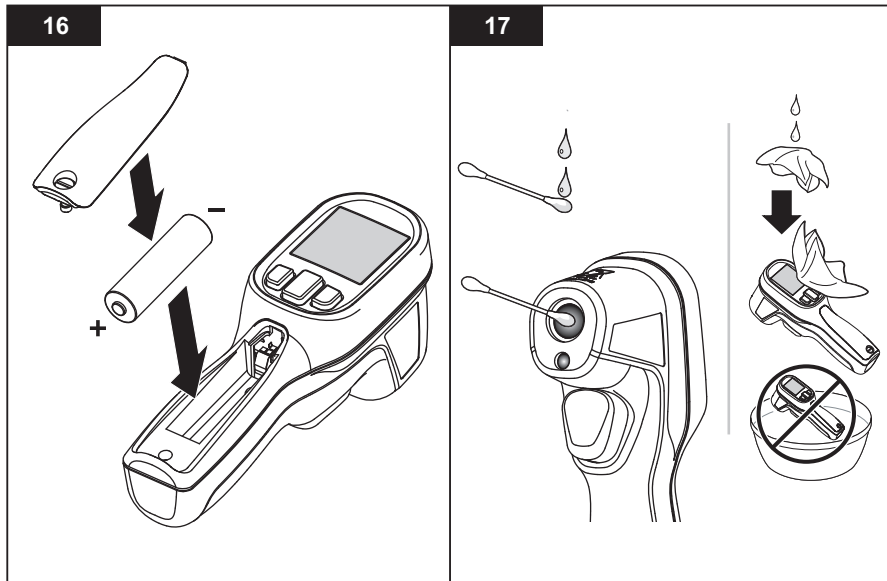

hdi13.eps



**敏盛企業有限公司**

<http://www.mavin.com.tw>

**免責聲明**

資料僅供參考，若有與原廠不合之處，請以原廠規格為準，且不供任何證明文件之用

TEL:03-5970828 FAX:03-5972622 新竹湖口工業區工業四路3號2F