

572-2

Infrared Thermometer

Users Manual

March 2013, Rev. 1, 08/13

©2013 Fluke Corporation. All rights reserved. Specifications are subject to change without notice.
All product names are trademarks of their respective companies.



敏盛企業有限公司

<http://www.mavin.com.tw>

免責聲明

資料僅供參考，若有與原廠不合之處，請以原廠規格為準，且不供任何證明文件之用

TEL:03-5970828 FAX:03-5972622 新竹湖口工業區工業四路3號2F

LIMITED WARRANTY AND LIMITATION OF LIABILITY

Each Fluke product is warranted to be free from defects in material and workmanship under normal use and service. The warranty period is two years and begins on the date of shipment. Parts, product repairs, and services are warranted for 90 days. This warranty extends only to the original buyer or end-user customer of a Fluke authorized reseller, and does not apply to fuses, disposable batteries, or to any product which, in Fluke's opinion, has been misused, altered, neglected, contaminated, or damaged by accident or abnormal conditions of operation or handling. Fluke warrants that software will operate substantially in accordance with its functional specifications for 90 days and that it has been properly recorded on non-defective media. Fluke does not warrant that software will be error free or operate without interruption.

Fluke authorized resellers shall extend this warranty on new and unused products to end-user customers only but have no authority to extend a greater or different warranty on behalf of Fluke. Warranty support is available only if product is purchased through a Fluke authorized sales outlet or Buyer has paid the applicable international price. Fluke reserves the right to invoice Buyer for importation costs of repair/replacement parts when product purchased in one country is submitted for repair in another country.

Fluke's warranty obligation is limited, at Fluke's option, to refund of the purchase price, free of charge repair, or replacement of a defective product which is returned to a Fluke authorized service center within the warranty period.

To obtain warranty service, contact your nearest Fluke authorized service center to obtain return authorization information, then send the product to that service center, with a description of the difficulty, postage and insurance prepaid (FOB Destination). Fluke assumes no risk for damage in transit. Following warranty repair, the product will be returned to Buyer, transportation prepaid (FOB Destination). If Fluke determines that failure was caused by neglect, misuse, contamination, alteration, accident, or abnormal condition of operation or handling, including overvoltage failures caused by use outside the product's specified rating, or normal wear and tear of mechanical components, Fluke will provide an estimate of repair costs and obtain authorization before commencing the work. Following repair, the product will be returned to the Buyer transportation prepaid and the Buyer will be billed for the repair and return transportation charges (FOB Shipping Point).

THIS WARRANTY IS BUYER'S SOLE AND EXCLUSIVE REMEDY AND IS IN LIEU OF ALL OTHER WARRANTIES, EXPRESS OR IMPLIED, INCLUDING BUT NOT LIMITED TO ANY IMPLIED WARRANTY OF MERCHANTABILITY OR FITNESS FOR A PARTICULAR PURPOSE. FLUKE SHALL NOT BE LIABLE FOR ANY SPECIAL, INDIRECT, INCIDENTAL OR CONSEQUENTIAL DAMAGES OR LOSSES, INCLUDING LOSS OF DATA, ARISING FROM ANY CAUSE OR THEORY.

Since some countries or states do not allow limitation of the term of an implied warranty, or exclusion or limitation of incidental or consequential damages, the limitations and exclusions of this warranty may not apply to every buyer. If any provision of this Warranty is held invalid or unenforceable by a court or other decision-maker of competent jurisdiction, such holding will not affect the validity or enforceability of any other provision.

Fluke Corporation
P.O. Box 9090
Everett, WA 98206-9090
U.S.A.

Fluke Europe B.V.
P.O. Box 1186
5602 BD Eindhoven
The Netherlands

11/99



敏盛企業有限公司

<http://www.mavin.com.tw>

免責聲明

資料僅供參考，若有與原廠不合之處，請以原廠規格為準，且不供任何證明文件之用

TEL:03-5970828 FAX:03-5972622 新竹湖口工業區工業四路3號2F

Table of Contents

Title	Page
Introduction.....	1
Contact Fluke.....	1
Safety Information.....	2
Features.....	4
Display.....	5
Menu Overview.....	5
Save.....	6
Light.....	6
Memory.....	6
Emissivity Menu.....	6
°C and °F.....	7
Min, Max, Avg, Differential.....	8
Alarm.....	8
Trigger Lock.....	8
Laser.....	9
Setup.....	9
Language.....	9
Backlight.....	9
Time/Date.....	9
Delete Data.....	10
Delete All Data.....	10
Delete Individual Data Records.....	10
How the Product Works.....	11
Product Operation.....	11
Temperature Measurement.....	11
Locate a Hot or Cold Spot.....	12
Distance and Spot Size.....	12
Field of View.....	13
Emissivity.....	13
HOLD.....	13
Data Storage.....	14
Data Download.....	14
External Contact Probe.....	15
Troubleshooting.....	15
Maintenance.....	16
Battery Charge.....	16

Battery Replacement.....	16
Clean the Lens	17
Clean the Case	17
User-Replaceable Parts and Accessories	17
User-Replaceable Parts.....	17
Accessories.....	18
Recommended Temperature Probes.....	18
Specifications.....	19
K-Type Thermocouple Bead Probe Specifications	20

List of Tables

Table	Title	Page
1.	Symbols.....	3
2.	Top-Level Menu Description.....	5
3.	Nominal Surface Emissivity.....	7
4.	Troubleshooting.....	15
5.	Replaceable Parts.....	17
6.	Recommended Temperature Probes.....	18

List of Figures

Figure	Title	Page
1.	Safety Markings	3
2.	Menu Navigation.....	5
3.	How the Product Works.....	11
4.	Locating a Hot or Cold Spot	12
5.	Distance and Spot Size	12
6.	Field of View.....	13
7.	Thermocouple and USB Connections	14
8.	Battery Replacement	17

Introduction

The 572-2 Infrared Thermometer (the Product) is for non-contact temperature measurement. The Product determines the surface temperature of an object by measuring the amount of infrared energy radiated by the object surface. The Product also uses a K-type thermocouple for contact temperature measurement.

Contact Fluke

To contact Fluke, call one of the following telephone numbers:

- Technical Support USA: 1-800-44-FLUKE (1-800-443-5853)
- Calibration/Repair USA: 1-888-99-FLUKE (1-888-993-5853)
- Canada: 1-800-36-FLUKE (1-800-363-5853)
- Europe: +31 402-675-200
- Japan: +81-03-6714-3114
- Singapore: +65-738-5566
- Anywhere in the world: +1-425-446-5500

Or, visit Fluke's website at www.fluke.com.

To register your product, visit <http://register.fluke.com>.

To see, print, or download the latest manual supplement, visit <http://us.fluke.com/user/support/manuals>.

Safety Information

A **Warning** identifies conditions and procedures that are dangerous to the user. A **Caution** identifies conditions and procedures that can cause damage to the Product or the equipment under test.

Symbols used on the Product and in this manual are explained in Table 1. Laser safety markings are shown in Figure 1.

Warning

To prevent possible electrical shock, fire, eye damage, and personal injury:

- Read all safety Information before you use the Product.
- Use the Product only as specified, or the protection supplied by the Product can be compromised.
- Do not use the Product around explosive gas, vapor, or in damp or wet environments.
- Do not use the Product if it operates incorrectly.
- See emissivity information for actual temperatures. Reflective objects result in lower than actual temperature measurements. These objects pose a burn hazard.
- Do not look directly into the laser with optical tools (for example, binoculars, telescopes, microscopes). Optical tools can focus the laser and be dangerous to the eye.
- Do not look into the laser. Do not point laser directly at persons or animals or indirectly off reflective surfaces.
- Use the product only as specified, or hazardous laser radiation exposure can occur.
- Do not use laser viewing glasses as laser protection glasses. Laser viewing glasses are used only for better visibility of the laser in bright light.
- Do not open the Product. The laser beam is dangerous to eyes. Have the Product repaired only through an approved technical site.
- Have an approved technician repair the product.

Caution

For safe operation and maintenance of the Product:

- Remove the batteries if the Product is not used for an extended period of time, or if stored in temperatures above 50 °C. If the batteries are not removed, battery leakage can damage the Product.
- Replace the batteries when the low battery indicator shows to prevent incorrect measurements.
- Have the Product repaired before use if the batteries leak.
- Be sure that the battery polarity is correct to prevent battery leakage.
- Do not short the battery terminals together.











- Do not keep cells or batteries in a container where the terminals can be shorted.
- Do not put battery cells and battery packs near heat or fire. Do not put in sunlight.

⚠ Caution

To avoid damage to the Product or the equipment under test, protect them from:

- EMF (electro-magnetic fields) from arc welders, induction heaters, etc.
- Static electricity
- Thermal shock (caused by large or abrupt ambient temperature changes. For highest accuracy, allow 30 minutes for Thermometer to become stable before use).

Table 1. Symbols

Symbol	Explanation
	Hazardous voltage. Risk of electrical shock.
	Risk of danger. Important information. See manual.
	Warning. Laser.
	Conforms to European Union directives.
	Celsius
	Fahrenheit
	Battery
	This product complies with the WEEE Directive (2002/96/EC) marking requirements. The affixed label indicates that you must not discard this electrical/electronic product in domestic household waste. Product Category: With reference to the equipment types in the WEEE Directive Annex I, this product is classed as category 9 "Monitoring and Control Instrumentation" product. Do not dispose of this product as unsorted municipal waste. Go to Fluke's website for recycling information.
	Battery
	Conforms to relevant South Korean EMC Standards.
 沪制01120009号	Conforms to China Metrology Certification.

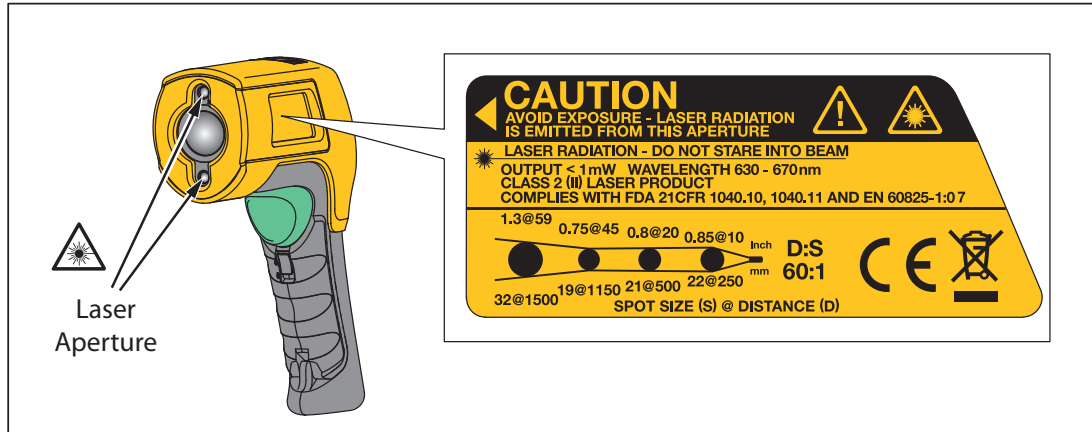

Figure 1. Safety Markings

hdp01.eps

Features

- Dual laser sighting
- Backlit display
- Current Temperature plus MAX, MIN, DIF, AVG temperature displays
- Two AA batteries
- Hard case
- 80PK-1 K-type thermocouple probe
- Adjustable emissivity and predefined emissivity table
- Infrared and thermocouple temperature display
- Celsius or Fahrenheit temperature display
- Tripod mount
- Auto off
- Standard miniature K-type thermocouple connector input
- Printed *572-2 Getting Started*
- *572-2 Manuals CD*
- 12 or 24 hour clock
- Last reading Hold (20 seconds)
- Multi-language interface
- High and low temperature alarm
- Data storage and review
- Trigger lock
- USB 2.0 computer interface cable
- FlukeView® Forms Documenting Software

Display

The Product display can show data in these languages:

- English
- Spanish
- French
- German
- Portuguese
- Simplified Chinese

To change the displayed language, refer to “Setup”.

Menu Overview

There are many settings that can be changed with the menu. Figure 2 shows the LCD and menu interface. Selecting the **Menu** softkey advances the menu to the next level. Table 2 is a top-level description of the menu.

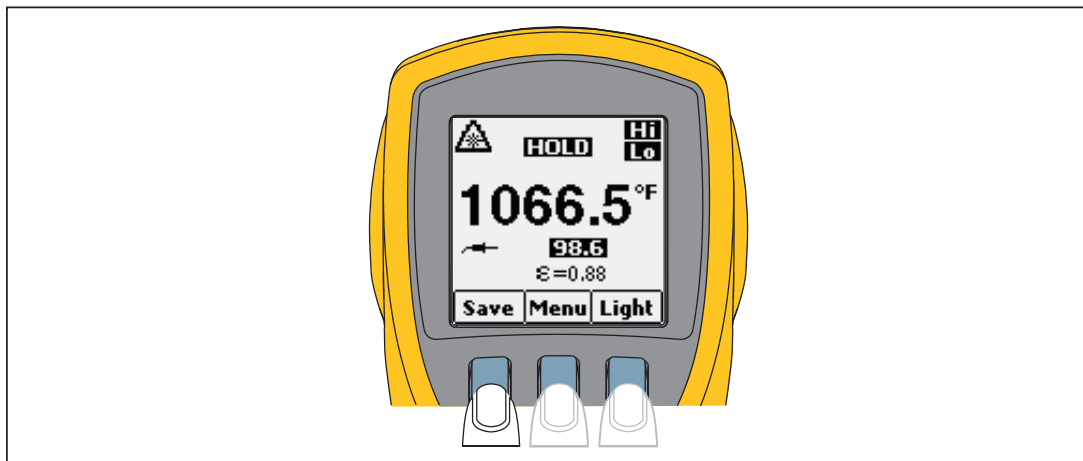

Figure 2. Menu Navigation

hdp02.eps

Table 2. Top-Level Menu Description

Level	Left Softkey	Description	Center Softkey	Right Softkey	Description
1	Save	Save reading to memory	Menu	Light	Adjust backlight brightness
2	Mem	Review/delete memory entries	Menu	ε	Set emissivity
3	MnMx	Enables Min/Max	Menu	Avg	Enable Avg/Diff
4	°C/°F	Toggle between C and F	Menu	Alarm	Set and enable alarms
5	🔒 (Lock)	Lock the Product on	Menu	Laser	Toggle the laser on/off
6	Setup	- Turn off/on backlight - Change Time/Date - Change Language	Menu	-	-

Each menu item and function is explained in greater detail in the following sections.

Save

To save readings:

1. Pull the trigger to take a measurement.
2. Release the trigger to stop taking the measurement.
3. Push the **Save** softkey to enter the Save menu.
4. Push the **Yes** softkey to save the reading.

The reading is assigned a memory location and a time and date stamp.

The reading includes:

- IR temperature
- Emissivity
- Date/Time

You can also push the **Cancel** softkey to abort saving the reading.

Light

The Product has a backlit display with two brightness levels. The **Light** softkey is used to adjust the backlight brightness. The backlight is on each time the trigger is pulled.

To toggle the backlight brightness, push the **Light** softkey.

The backlight can be disabled using the Setup menu. See “Setup” for more information.

Memory

The Product can store measurement records including time, date, emissivity, and measurement record numbers (see “Save” for more information). The Product can store 99 records.

To access records stored in memory:

1. Push the **Menu** softkey until **Mem** shows as the left softkey function.
2. Push the **Mem** softkey to access the Memory menu. Saved readings can be read.

Emissivity Menu

The Emissivity menu includes a list of pre-defined materials and lists their typical emissivity values, see Table 3. For further information, see “Emissivity”.

Note

Default emissivity is 0.95.

To access the Emissivity menu:

1. Push the **Menu** softkey until **E** (emissivity) shows as the right softkey function.
2. Push the **E** softkey.

You can push the **Table** softkey to access the Emissivity list. You can also push the **No.** softkey to manually enter the typical emissivity of a material.

- If the Emissivity table is accessed, a list of materials and their suggested emissivity is shown.
 1. Use the down arrow to navigate through the list.
 2. Push the **Enter** softkey to choose the desired material.
- To enter an emissivity value manually:
 1. Push the **No.** softkey.
 2. Use the down or up arrow softkey to change the entry. Hold down the up or down arrow softkey to increase the rate of change.
 3. Push the **Done** softkey when finished to return to the main menu.

Table 3. Nominal Surface Emissivity

Material	Value	Material	Value
Default****	0.95	Glass (plate)	0.85
Aluminum*	0.30	Iron*	0.70
Asbestos	0.95	Lead*	0.50
Asphalt	0.95	Oil	0.94
Brass*	0.50	Paint	0.93
Ceramic	0.95	Plastic**	0.95
Concrete	0.95	Rubber	0.95
Copper*	0.60	Sand	0.90
Food - Frozen	0.90	Steel*	0.80
Food - Hot	0.93	Water	0.93
		Wood ***	0.94
* Oxidized ** Opaque, over 20 mils *** Natural **** Factory Setting Highlighted items may also be found in the emissivity table built into the Product.			

°C and °F

To toggle between °C (Celsius) and °F (Fahrenheit) measurements, push the **Menu** softkey until °C or °F shows as the left softkey function. Push the corresponding softkey to change between the measurements.

Min, Max, Avg, Differential

The Product can measure minimum (MIN), maximum (MAX), average (AVG), or differential (Δ) temperatures each time a reading is taken. These values are not shown if a thermocouple is plugged into the Product.

To turn on the Min Max mode:

1. Push the **Menu** softkey until **MnMx** (Min Max) shows as the left softkey function.
2. Push the **MnMx** softkey.

The display shows the present reading, maximum and minimum readings, and the emissivity setting.

To turn on the Avg/Dif mode:

1. Push the **Menu** softkey until **Avg** shows as the right softkey function.
2. Push the **Avg** softkey.

The display shows the present reading, average reading, the differential reading between max and min (designated by Δ), and the emissivity setting.

Alarm

The Product has a programmable high and low alarm to designate high or low readings, depending on the thresholds entered. When the alarm level is reached, an alarm will sound and the display will flash orange and white. To set either the high or low alarm:





1. Push the **Menu** softkey until **Alarm** shows as the right softkey function.
2. Push the **Alarm** softkey to access the Alarm menu.
3. Push either the **Hi** or **Lo** softkey, depending on which alarm will be set.
4. Push the **ON** softkey to turn the alarm on.
5. Push the **OFF** softkey to turn the alarm off.
6. Use the **Set** softkey to access the Hi or Lo Alarm Set menu.
7. Use the down or up softkeys to change the alarm setting.
8. Once the necessary settings have been entered, push the **Done** softkey.

Trigger Lock

The Product trigger can be locked on for continuous measurement.

To enable continuous measurement mode, hold down the trigger for a few seconds until the  symbol shows.

To lock the trigger:

1. Push the **Menu** softkey until the lock symbol () shows as the left softkey function.
2. Push the  softkey to lock the trigger. The lock symbol shows on the display to designate a locked trigger. When the trigger is locked, the  softkey changes to . Push this softkey to unlock the trigger.

Laser

Warning

To prevent eye damage and personal injury, do not look into the laser. Do not point laser directly at persons or animals or indirectly off reflective surfaces.

The laser of the Product is to be used for aiming purposes only. The laser turns off when the trigger is released.

To enable or disable the laser:

1. Push the **Menu** softkey until **Laser** shows as the right softkey function.
2. Push the Laser softkey to enable or disable the laser.  shows on the display when the laser is enabled.

Setup

From the Setup menu, the backlight, time and date, and display language can be changed.

Language

To change the display language:

1. From the main menu, push the **Menu** softkey until **Setup** shows as the left softkey function.
2. Push the **Setup** softkey.
3. Use the down arrow softkey to move the indicator to **Language**.
4. Push the **Enter** softkey.
5. Use the down arrow to move the indicator to the desired language.
6. Push the **Enter** softkey to complete the language selection or push the **Back** softkey to return to the **Setup** menu.

Backlight

In normal use, the backlight is always on. Use this menu to change the backlight setting from on to off. Turn the backlight off to conserve battery power.

1. Push the **Menu** softkey until **Setup** shows as the left softkey function.
2. Push the **Setup** softkey.
3. **Backlight** has an indicator next to it. To enter the backlight menu, push the **Enter** softkey.
4. Push the **OFF** softkey to turn the backlight off, push the **ON** softkey to turn it on.
5. Push the **Back** softkey to return to the Setup menu.

Time/Date

To change the time on the Product:

1. Push the **Menu** softkey until **Setup** shows as the left softkey function.
2. Push the **Setup** softkey to enter the Setup menu.
3. Push the down arrow softkey to select **Time/Date**.
4. Push the **Enter** softkey.
5. Push the **Time** softkey.

6. Push the necessary time format softkey (**24hr** or **12hr**).
7. Use the up and down softkeys to change the selected hour to the correct hour.
8. Push the **Next** softkey to select the minutes.
9. Use the up and down softkeys to change the selection to the desired minute.
10. When in 12-hour mode, push the **Next** softkey to highlight the **am/pm** parameter.
11. Use the up and down softkey to change to **am** or **pm**.
12. Push the **Done** softkey when finished. The display reverts to the first page of the Time/Date menu.

To change the date on the Product:

1. From the main menu, push the **Menu** softkey until **Setup** shows as the left softkey function.
2. Push the **Setup** softkey.
3. Push the down arrow softkey to select **Time/Date**.
4. Push the **Enter** softkey.
5. Push the **Date** softkey.
6. Select the date format: Day/Month/Year (**dmy**) or Month/Day/Year (**mdy**).
7. Use the up and down softkeys to change the selected parameter.
8. Push the **Next** softkey and the arrow softkeys to select the month, date, or year parameters.
9. Use the up and down softkeys to change the selected parameter.
10. Push the **Next** softkey to move through each parameter.
11. Push the **Done** softkey when finished. The display reverts to the start of the Time/Date menu.

Delete Data

To delete stored data from the Product, from the main menu, push the **menu** softkey until **Mem** shows as the left softkey function. The last memory location shows on the display. To access the Delete menu, push the **Delete** softkey. From here, all of the Product memory or individual records can be deleted.

Delete All Data

To delete all of the records:

1. Push the **All** softkey.
2. At the confirmation screen, push the **Yes** softkey.

Delete Individual Data Records

To delete individual records:

1. Push the **View** softkey.
2. Use the down and up arrow softkeys to access the desired record.
3. Once the desired record is shown, push the **Yes** softkey to delete the record.
4. To cancel data deletion, pull the trigger.

How the Product Works

Infrared thermometers measure the surface temperature of an object. The Product optics sense emitted, reflected, and transmitted energy, which is collected and focused onto a detector. The Product electronics translate the signal into a temperature measurement and shows the measurement on the display (see Figure 3).

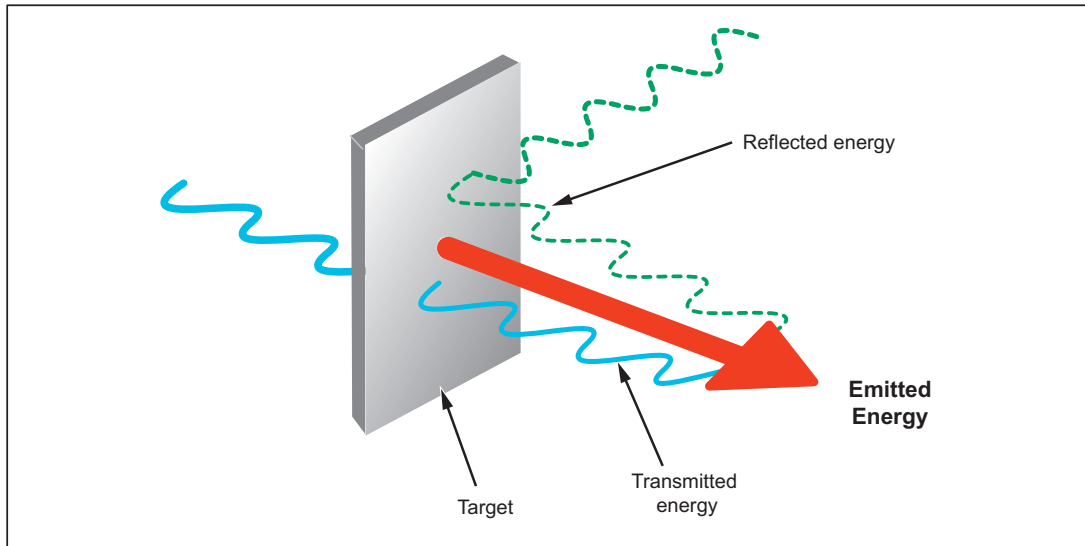

Figure 3. How the Product Works

hdp03.eps

Product Operation

Temperature Measurement

To measure temperature, point the Product at an object and pull the trigger. You can use the laser pointer to aim the Product. You can also insert the K-type thermocouple probe for contact measurement. Be sure to consider distance-to-spot size ratio and field of view (see “Distance and Spot Size” and “Field of View”). The temperature is shown on the display.

Note

The laser is used for aiming purposes only and is not related to temperature measurement.

The Product features an auto off function that automatically powers down the Product after 20 seconds of inactivity. To turn the Product on, pull the trigger.

Locate a Hot or Cold Spot

To find a hot or cold spot, aim the Product outside the desired area. Then, slowly scan across the area with an up and down motion until you locate the hot or cold spot (see Figure 4).

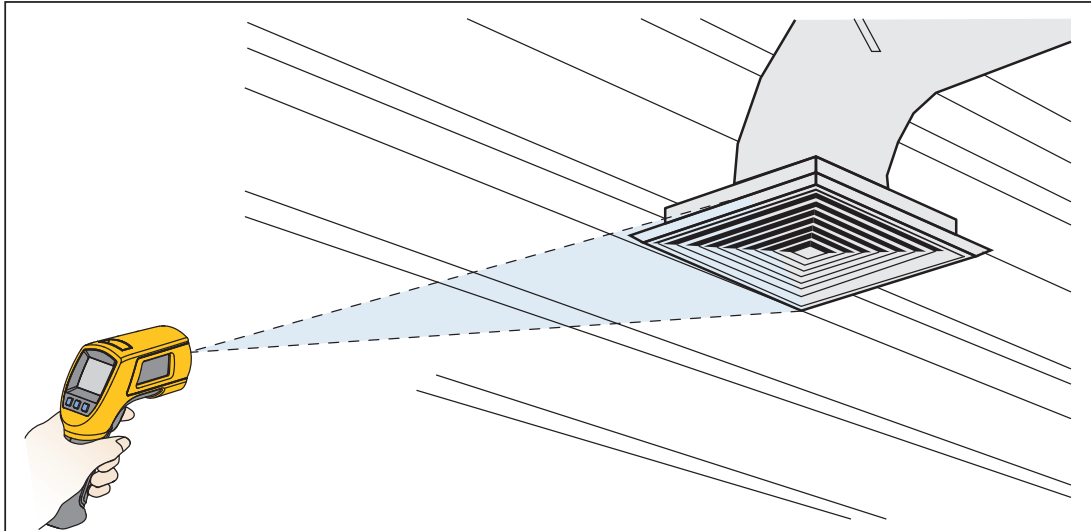

Figure 4. Locating a Hot or Cold Spot

hdp04.eps

Distance and Spot Size

As the distance (D) from the object being measured increases, the spot size (S) of the area measured by the Product becomes larger. The relationship between distance and spot size (D:S) for each Product is shown in Figure 5. The spot sizes indicate 90 % encircled energy.

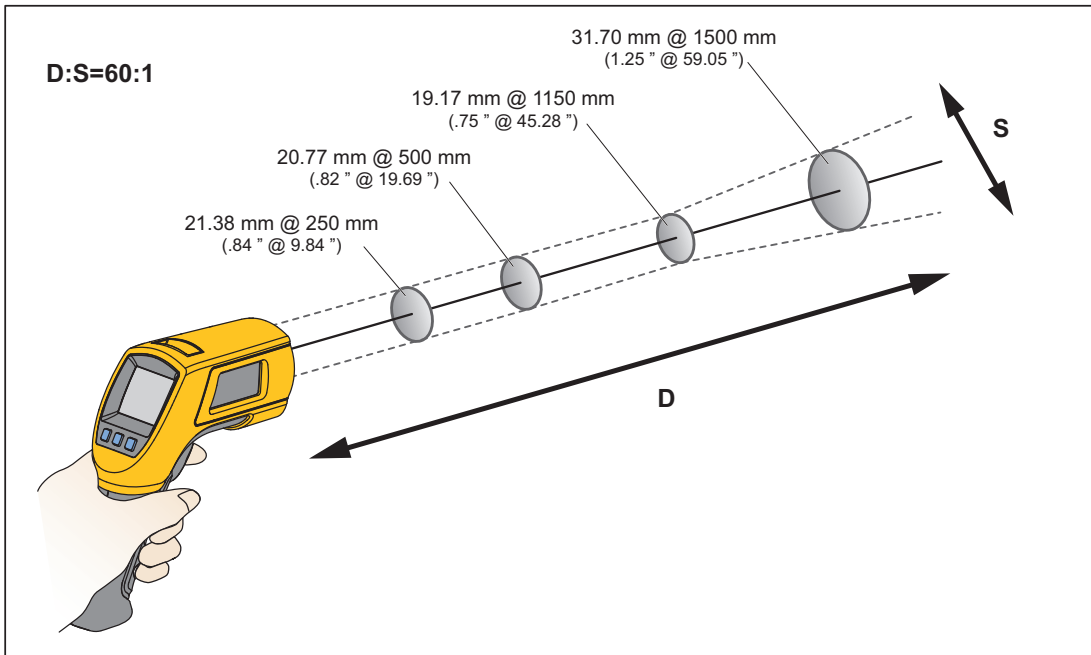

Figure 5. Distance and Spot Size

hdp05.eps

Field of View

For accurate measurements, make sure that the target is larger than the Product spot size. The smaller the target, the closer you should be to it (see Figure 6).

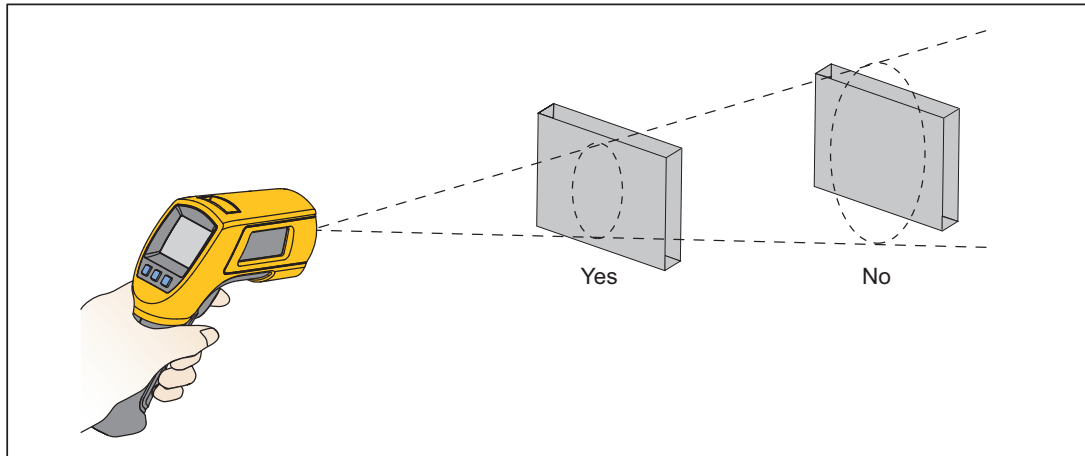

Figure 6. Field of View

hdp06.eps

Emissivity

Emissivity describes the energy-emitting characteristics of materials. Most organic materials and painted or oxidized surfaces have an emissivity of approximately 0.95, the default setting for the Product.

To compensate for inaccurate readings that may result from measuring shiny metal surfaces, you can cover the surface to be measured with electrical tape or flat black paint (<148 °C/300 °F) with emissivity set to 0.95. Allow time for the tape or paint to reach the same temperature as the surface beneath it. Measure the temperature of the tape or painted surface.

If you cannot paint or use tape, then you can improve the accuracy of your measurements by either numerically adjusting emissivity or by using the Emissivity Menu to access a table of some common materials. The Product has numerically-adjustable emissivity from 0.10 to 1.00 that can be used in conjunction with the emissivity in Table 3. Also, the Product has a built-in table of the most common materials that can be set from the Emissivity menu. The built-in values are indicated in Table 3.

HOLD

The display retains its last infrared measurement for twenty seconds when the trigger is released, when **HOLD** is shown on the display. With the probe inserted, the contact thermometer remains on. To freeze the infrared temperature when a probe is not inserted, release the trigger until **HOLD** shows on the display.

Data Storage

The Product can store up to 99 data records. The information below is stored in each record:

- Record number
- IR and probe temperature in °F or °C
- Date/Time
- Emissivity

For more information, see “Save”.

Data Download

The stored data can be downloaded to a personal computer (PC) with the included USB cable and the included FlukeView® Forms Documenting Software. See the FlukeView® Forms documentation for details. The USB input ② is located on the top of the Product next to the external probe input ① (see Figure 7).

Note

To prevent incorrect readings, do not do a temperature measurement of an earthed conductor while the Product is connected to a PC that is earthed by a three-phase grounding plug.

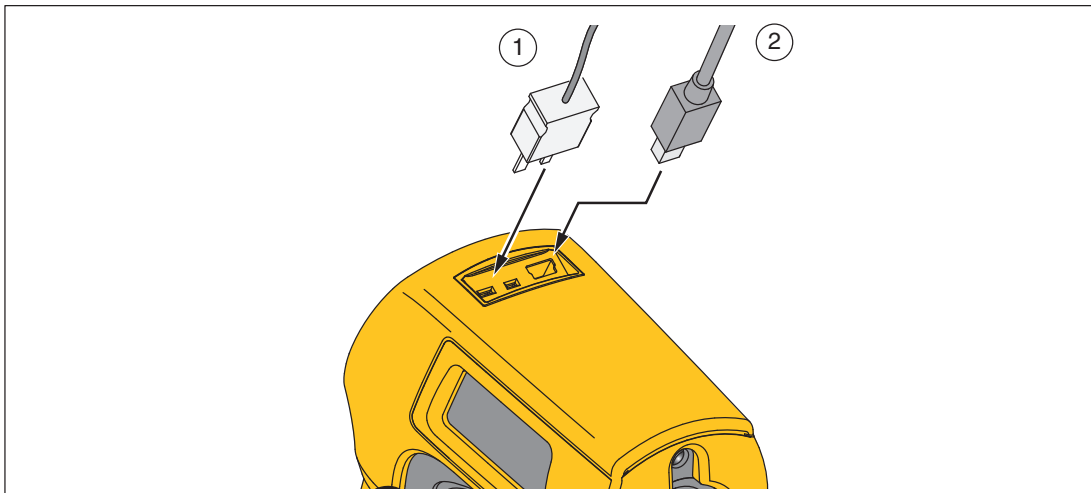

Figure 7. Thermocouple and USB Connections

hdp07.eps

External Contact Probe

Warning

To avoid electrical shock or personal injury, do not connect the external contact probe to live electrical circuits.

The Product comes with a bead K-type thermocouple probe. The probe attaches to the Product via the probe input located on the top of the Product (see Figure 7).

With the probe installed, the probe symbol () shows on the display. The probe can be used simultaneously while the Product is taking non-contact measurements. The probe measurements are shown below the non-contact measurements. The Product will stay on when there is a probe inserted. When used with a personal computer and FlukeView Forms, the auto off feature is disabled.

Troubleshooting

See Table 4 for solutions to possible problems when using the Product.

Table 4. Troubleshooting

Symptom	Cause	Action
--- (on display)	Target temperature is over or under range.	Select target within specifications
	Low batteries	Replace batteries
Blank display	Thermometer is asleep Possible dead batteries	Pull trigger Replace batteries
Laser does not work	Low or dead batteries Ambient temperature is above 40 °C (104 °F)	Replace batteries Use in area with lower ambient temperature
Failed communication via USB	Unit is off FlukeView Forms is not running	Pull the trigger Start FlukeView Forms
Inaccuracy	Possible incorrect emissivity setting, field of view, or spot size	See “Emissivity”, “Field of View” and “Distance and Spot Size” sections.
Settings such as emissivity, date/time, F/C, and saved data lost	Battery dead or not replaced in <1 minute of removal	Reset settings. Replace batteries as soon as low battery indicated; Exchange the batteries within one minute of removal. Refer to “Changing the Batteries”.

Maintenance

Battery Charge

Use the battery charge symbols to gauge the approximate level of charge left on the batteries.

Note

When in low battery mode, the Product does not store values. "Err" shows on the display if attempted.



Batteries are at 5 %. Before taking further readings, the batteries must be changed.

Battery Replacement

Warning

To prevent possible electrical shock, fire, eye damage, and personal injury:

- Do not open the Product. The laser beam is dangerous to eyes. Have the Product repaired only through an approved technical site.
- Have an approved technician repair the Product.

For safe operation and maintenance of the Product:

- Repair the Product before use if the batteries leak.
- Be sure that the battery polarity is correct to prevent battery leakage.

Caution

- Do not short the battery terminals together.
- Do not keep cells or batteries in a container where the terminals can be shorted.
- Do not put battery cells and battery packs near heat or fire. Do not put in sunlight.

Note

The batteries should be replaced in less than one minute after removal to avoid manually re-initializing the Product clock and date.

To install or change the two AA batteries (see Figure 8):

1. Slide the locking tab on the battery door to the "☐" position and then open the handle.
2. Insert the batteries noting their correct polarity.
3. Close and lock the handle.

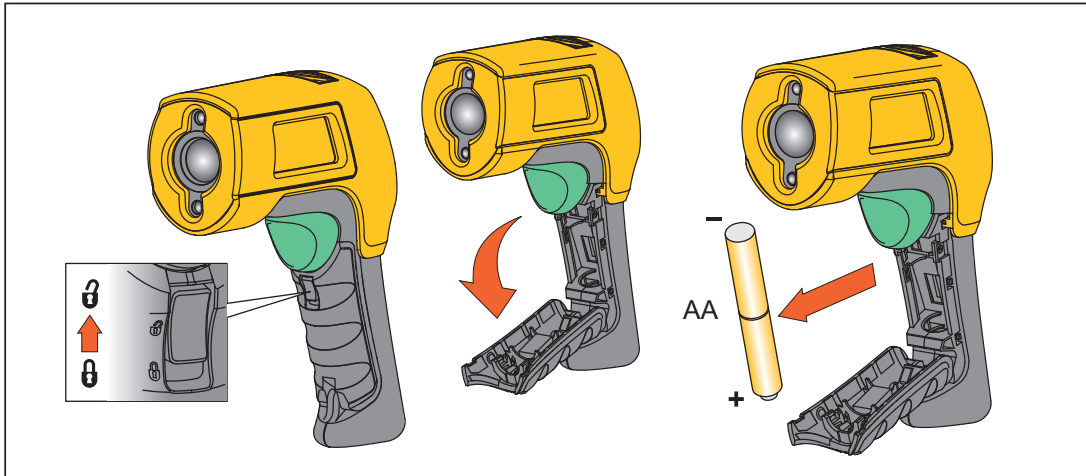

Figure 8. Battery Replacement

hdp08.eps

Clean the Lens

Blow off loose particles. Carefully wipe the surface with a water-moistened cotton swab.

Clean the Case

Use soap and water on a damp sponge or soft cloth.

⚠ Caution

To avoid damaging the Product, do NOT submerge it in water. Do not use abrasive cleaners, they will damage the case.

User-Replaceable Parts and Accessories

User-Replaceable Parts

See Table 5 for a list of replaceable parts.

Table 5. Replaceable Parts

Part	Part Number
572-2 Manuals CD	4307031
572-2 Getting Started (English, French, German, Spanish, Portuguese, Russian, Simplified Chinese)	4307046

Accessories

Optional accessories for the Product are:

- Soft Carrying Case (H6)
- Calibration Certification
- All K-type thermocouple probes with standard mini-connector. See Table 7 for more information.

Recommended Temperature Probes

Warning



To avoid electrical shock or personal injury, do not connect the external contact probe to live electrical circuits.

See Table 6 for a list of recommended temperature probes.

Table 6. Recommended Temperature Probes

Probe	Usage
80PK-1	The general purpose bead probe is for quick, accurate surface temperatures and air temperatures within ducts, vent temperatures.
80PK-8	Pipe clamp probes (2) are essential for tracking continuously changing temperature differentials on hydronic tubing and pipe loops, and good for quick, accurate refrigerant temperatures.
80PK-9	The insulation-piercing probe provides a sharp tip to pierce pipe insulation and flat probe tip for good surface thermal contact, air temperatures within ducts, and vent temperatures.
80PK-11	Flexible cuff thermocouple temperature probe is a convenient way to attach a thermocouple to a pipe while keeping hands free.
80PK-25	The piercing probe is the most versatile option. Good for checking air temperature in ducts, surface temperature under carpets/pads, liquids, thermometer wells, vent temperatures, and for penetrating pipe insulation.
80PK-26	The tapered probe is a good general-purpose gas and surface probe, with a good length and low mass tip casing for faster reaction to surface and air temperatures.

Specifications

Thermal	
IR Temperature Range	-30 °C to 900 °C (-22 °F to 1652 °F)
IR Accuracy (Calibration geometry with ambient temperature 23 °C±2 °C)	≥0 °C: ± 1 °C or ± 1 % of reading, whichever is greater (≥32 °F: ± 2 °F or ± 1 % of reading, whichever is greater) ≥-10 °C to <0 °C: ±2 °C(≥14 °F to <32 °F: ±4 °F) <-10°C: ±3 °C (<14 °F: ±6 °F)
IR Repeatability	±0.5 % of reading or ±0.5 °C (±1 °F), whichever is greater.
Display Resolution	0.1 °C / 0.1 °F
Spectral Response	8 μm to 14 μm
Response Time (95 %)	<500 ms
K-Type Thermocouple Input Temperature Range	-270 °C to 1372 °C (-454 °F to 2501 °F)
K-Type Thermocouple Input Accuracy (with ambient temperature 23 °C±2 °C)	<-40 °C: ±(1 °C + 0.2 %/1 °C) ≥-40 °C: ±1 % or 1 °C, whichever is greater <-40 °F: ±(2 °F + 0.2 %/1 °F) ≥-40 °F: ±1 % or 2 °F, whichever is greater
K-Type Thermocouple Repeatability	±0.5 % of reading or ±0.5 °C (±1 °F), whichever is greater
K-Type Thermocouple Resolution	0.1 °C/0.1 °F
Optical	
Distance:Spot (90 % energy)	60:1(calculated at 90 % energy)
Laser sighting	Offset dual laser, output <1 mW
Minimum spot size	19 mm
Operational	
Emissivity	Digitally adjustable from 0.10 to 1.00 by 0.01 or via built-in table of common materials (see Table 3 for list of materials and value)
Probe input	KTC (Should display simultaneous probe and IR temperature)
Data storage	99 points
Communication	USB 2.0
Operating Altitude	2000 meters
Storage Altitude	12,000 meters
Relative Humidity	10 % to 90 % RH non-condensing up to 30 °C (86 °F)
Operating Temperature	0 °C to 50 °C (32 °F to 122 °F)
Storage Temperature	-20 °C to 60 °C (-4 °F to 140 °F)
Vibration	2.5 G, IEC 60068-2-6
Weight	0.322 kg (0.7099 lb)
Dimensions	17.69 cm (6.965 in) H x 16.36 cm (6.441 in) L x 5.18 cm (2.039 in) W
Power	2 AA Batteries
Battery Life	8 hours with laser and backlight on; 100 hours with laser and backlight off, at 100 % duty cycle (thermometer continuously on)
Standards and Agency Approval	EMC: meets IEC61326-1: Portable Safety Compliance: IEC 60825-1, Class 2  沪制01120009号 Implement Standard: Q/SXAV 16  

Electromagnetic Compatibility	Applies to use in Korea only, Class A equipment; (Industrial Broadcasting & Communication Equipment) ^[1] [1] This product meets the requirement for industrial (Class A) electromagnetic wave equipment and seller or user should take notice of it. This equipment is intended for use in business environment and is not to be used in homes.
--------------------------------------	---

K-Type Thermocouple Bead Probe Specifications

Measurement Range	-40 °C to 260 °C (-40 °F to 500 °F)
Accuracy	±1.1 °C (±2.0 °F) from 0 °C to 260 °C (32 °F to 500 °F). Typically within 1.1 °C (2.0 °F) from -40 °C to 0 °C (-40 °F to 32 °F)
Cable Length	1 m (40 in) K-type thermocouple cable with standard miniature thermocouple connector and bead termination