



Tektronix Model PA4000 Power Analyzer manual addendum.



WARNING - Risk of serious personal injury or death from electric shock. Please read immediately before using your PA-4000.

The specification of the Tektronix Model PA-4000 has changed to 600 Vrms maximum.

Everywhere in this manual where a maximum voltage rating of 1000 Vrms is stated, it should read 600 Vrms.

Your product should also be labeled for 600 Vrms maximum on the rear panel. If your product is still labeled for 1000 Vrms, call your local Tektronix customer service center to arrange a recall and correction of your instrument.

The correct rear panel label is shown:

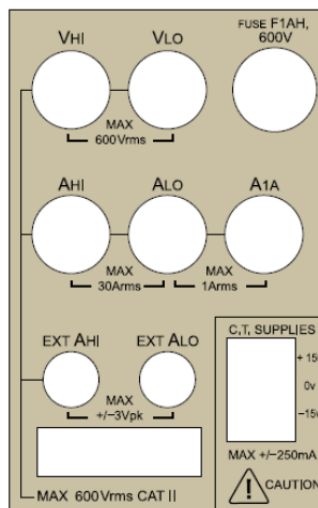

**PA4000
Power Analyzer
User Manual**



077-0815-01

Tektronix

**PA4000
Power Analyzer
User Manual**

Firmware version 1.0.037

www.tektronix.com

077-0815-01

Tektronix

Copyright © Tektronix. All rights reserved. Licensed software products are owned by Tektronix or its subsidiaries or suppliers, and are protected by national copyright laws and international treaty provisions.

Tektronix products are covered by U.S. and foreign patents, issued and pending. Information in this publication supersedes that in all previously published material. Specifications and price change privileges reserved.

TEKTRONIX and TEK are registered trademarks of Tektronix, Inc.

Contacting Tektronix

Tektronix, Inc.
14150 SW Karl Braun Drive
P.O. Box 500
Beaverton, OR 97077
USA

For product information, sales, service, and technical support:

- In North America, call 1-800-833-9200.
- Worldwide, visit www.tektronix.com to find contacts in your area.

Warranty

Tektronix warrants that this product will be free from defects in materials and workmanship for a period of three (3) years from the date of shipment. If any such product proves defective during this warranty period, Tektronix, at its option, either will repair the defective product without charge for parts and labor, or will provide a replacement in exchange for the defective product. Parts, modules and replacement products used by Tektronix for warranty work may be new or reconditioned to like new performance. All replaced parts, modules and products become the property of Tektronix.

In order to obtain service under this warranty, Customer must notify Tektronix of the defect before the expiration of the warranty period and make suitable arrangements for the performance of service. Customer shall be responsible for packaging and shipping the defective product to the service center designated by Tektronix, with shipping charges prepaid. Tektronix shall pay for the return of the product to Customer if the shipment is to a location within the country in which the Tektronix service center is located. Customer shall be responsible for paying all shipping charges, duties, taxes, and any other charges for products returned to any other locations.

This warranty shall not apply to any defect, failure or damage caused by improper use or improper or inadequate maintenance and care. Tektronix shall not be obligated to furnish service under this warranty a) to repair damage resulting from attempts by personnel other than Tektronix representatives to install, repair or service the product; b) to repair damage resulting from improper use or connection to incompatible equipment; c) to repair any damage or malfunction caused by the use of non-Tektronix supplies; or d) to service a product that has been modified or integrated with other products when the effect of such modification or integration increases the time or difficulty of servicing the product.

THIS WARRANTY IS GIVEN BY TEKTRONIX WITH RESPECT TO THE PRODUCT IN LIEU OF ANY OTHER WARRANTIES, EXPRESS OR IMPLIED. TEKTRONIX AND ITS VENDORS DISCLAIM ANY IMPLIED WARRANTIES OF MERCHANTABILITY OR FITNESS FOR A PARTICULAR PURPOSE. TEKTRONIX' RESPONSIBILITY TO REPAIR OR REPLACE DEFECTIVE PRODUCTS IS THE SOLE AND EXCLUSIVE REMEDY PROVIDED TO THE CUSTOMER FOR BREACH OF THIS WARRANTY. TEKTRONIX AND ITS VENDORS WILL NOT BE LIABLE FOR ANY INDIRECT, SPECIAL, INCIDENTAL, OR CONSEQUENTIAL DAMAGES IRRESPECTIVE OF WHETHER TEKTRONIX OR THE VENDOR HAS ADVANCE NOTICE OF THE POSSIBILITY OF SUCH DAMAGES.

[W4 – 15AUG04]

Table of Contents

General safety summary	vi
Compliance information	viii
EMC compliance	viii
Safety compliance	x
Environmental considerations	xii
Preface	xiii
Features and abilities	xiii
Package contents	xiii
Accessories	xiv
Getting started	1
Before you begin - safety	1
Power on	2
Concept of global, group and channel parameters	3
Connecting to the product under test	4
Default measurements	6
Navigating the results screen	7
Navigating the menu system	8
On screen help	9
Front panel operation	11
Front panel layout	11
Quick view buttons	11
Soft keys	21
Operational and alphabetical buttons	22
Number and equation buttons	23
Logging data to a memory device	24
Connecting signals	26
Input overview	26
To connect a simple current transformer	28
To connect an external resistive shunt	29
To connect a transducer with a voltage output	30
To connect a voltage transformer / transducer	31
Power for external transducers	32
The menu system	33
Navigation	33
Menu items	33
Main menu	33
Measurements	33
Measurements configuration	37
Modes	40

Inputs.....	44
Graphs and waveforms.....	50
Interfaces	51
Datalog.....	52
Math.....	52
System configuration	55
User configuration	57
Remote operation.....	59
Overview	59
Interfacing with RS232 systems	59
Interfacing with USB systems.....	59
Interfacing with Ethernet systems.....	59
Interfacing with GPIB systems (optional)	60
Status reporting	60
Command listing.....	63
IEEE 488.2 standard commands and status commands	64
Channel and group commands	66
Unit information commands.....	67
Measurement selection and reading commands	67
Measurement configuration commands	71
Mode setup commands.....	76
Input setup commands	78
Graph and waveform commands.....	83
Interface commands	83
Datalog command	85
Math commands	86
System configuration commands.....	87
User configuration commands.....	90
Sending and receiving commands	90
Communications examples	91
Software	94
PA4000 download software.....	94
Specifications	96
Measurement channel	96
Power input.....	97
Mechanical and environmental.....	97
Optional parts	97
Communication ports.....	98
Auxiliary inputs/outputs	100
Host/Client port	101
Measured parameters.....	101

One phase, three wire SUM formulae	103
Three phase, four wire SUM formulae	104
Measurement accuracy	104
Index	

List of Figures

List of Tables

Table 1: Phase measurements 101

General safety summary

Review the following safety precautions to avoid injury and prevent damage to this product or any products connected to it.

To avoid potential hazards, use this product only as specified.

Only qualified personnel should perform service procedures.

While using this product, you may need to access other parts of a larger system. Read the safety sections of the other component manuals for warnings and cautions related to operating the system.

To avoid fire or personal injury

Use proper power cord. Use only the power cord specified for this product and certified for the country of use.

Connect and disconnect properly. Do not connect or disconnect probes or test leads while they are connected to a voltage source.

Connect and disconnect properly. De-energize the circuit under test before connecting or disconnecting the current probe.

Ground the product. This product is grounded through the grounding conductor of the power cord. To avoid electric shock, the grounding conductor must be connected to earth ground. Before making connections to the input or output terminals of the product, ensure that the product is properly grounded.

Observe all terminal ratings. To avoid fire or shock hazard, observe all ratings and markings on the product. Consult the product manual for further ratings information before making connections to the product.

Do not apply a potential to any terminal, including the common terminal, that exceeds the maximum rating of that terminal.

Power disconnect. The power switch disconnects the product from the power source. See instructions for the location. Do not block the power switch; it must remain accessible to the user at all times.

Do not operate without covers. Do not operate this product with covers or panels removed.

Do not operate with suspected failures. If you suspect that there is damage to this product, have it inspected by qualified service personnel.

Avoid exposed circuitry. Do not touch exposed connections and components when power is present.

Use proper fuse. Use only the fuse type and rating specified for this product.

Do not operate in wet/damp conditions.

Do not operate in an explosive atmosphere.

Keep product surfaces clean and dry.

Provide proper ventilation. Refer to the manual's installation instructions for details on installing the product so it has proper ventilation.

Terms in this manual These terms may appear in this manual:



WARNING. *Warning statements identify conditions or practices that could result in injury or loss of life.*



CAUTION. *Caution statements identify conditions or practices that could result in damage to this product or other property.*

Symbols and terms on the product

These terms may appear on the product:

- DANGER indicates an injury hazard immediately accessible as you read the marking.
- WARNING indicates an injury hazard not immediately accessible as you read the marking.
- CAUTION indicates a hazard to property including the product.

The following symbol(s) may appear on the product:

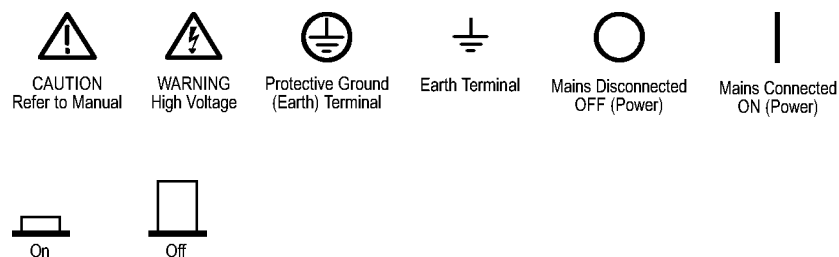

Compliance information

This section lists the EMC (electromagnetic compliance), safety, and environmental standards with which the instrument complies.

EMC compliance

EC Declaration of Conformity – EMC

Meets intent of Directive 2004/108/EC for Electromagnetic Compatibility. Compliance was demonstrated to the following specifications as listed in the Official Journal of the European Communities:

EN 61326-1 2006. EMC requirements for electrical equipment for measurement, control, and laboratory use.^{1 2 3}

- CISPR 11:2003. Radiated and conducted emissions, Group 1, Class A
- IEC 61000-4-2:2001. Electrostatic discharge immunity
- IEC 61000-4-3:2002. RF electromagnetic field immunity
- IEC 61000-4-4:2004. Electrical fast transient / burst immunity
- IEC 61000-4-5:2001. Power line surge immunity
- IEC 61000-4-6:2003. Conducted RF immunity
- IEC 61000-4-11:2004. Voltage dips and interruptions immunity

EN 61000-3-2:2006. AC power line harmonic emissions

EN 61000-3-3:1995. Voltage changes, fluctuations, and flicker

European contact.

Tektronix UK, Ltd.
Western Peninsula
Western Road
Bracknell, RG12 1RF
United Kingdom

EC Declaration of Conformity – EMC

Meets intent of Directive 2004/108/EC for Electromagnetic Compatibility. Compliance was demonstrated to the following specifications as listed in the Official Journal of the European Communities:

EN 61326-1:2006, EN 61326-2-1:2006. EMC requirements for electrical equipment for measurement, control, and laboratory use.^{1 2 3}

- CISPR 11:2003. Radiated and conducted emissions, Group 1, Class A
- IEC 61000-4-2:2001. Electrostatic discharge immunity

- IEC 61000-4-3:2002. RF electromagnetic field immunity
- IEC 61000-4-4:2004. Electrical fast transient/burst immunity
- IEC 61000-4-5:2001. Power line surge immunity
- IEC 61000-4-6:2003. Conducted RF immunity
- IEC 61000-4-11:2004. Voltage dips and interruptions immunity⁴

EN 61000-3-2:2006. AC power line harmonic emissions

EN 61000-3-3:1995. Voltage changes, fluctuations, and flicker

European contact.

Tektronix UK, Ltd.
Western Peninsula
Western Road
Bracknell, RG12 1RF
United Kingdom

- ¹ This product is intended for use in nonresidential areas only. Use in residential areas may cause electromagnetic interference.
- ² Emissions which exceed the levels required by this standard may occur when this equipment is connected to a test object.
- ³ For compliance with the EMC standards listed here, high quality shielded interface cables should be used.
- ⁴ Performance Criterion C applied at the 70%/25 cycle Voltage-Dip and the 0%/250 cycle Voltage-Interruption test levels (IEC 61000-4-11).

Safety compliance

EC Declaration of Conformity – Low Voltage

Compliance was demonstrated to the following specification as listed in the Official Journal of the European Communities:

Low Voltage Directive 2006/95/EC.

- EN 61010-1: 2001. Safety requirements for electrical equipment for measurement control and laboratory use.

U.S. nationally recognized testing laboratory listing

- UL 61010-1:2004, 2nd Edition. Standard for electrical measuring and test equipment.

Canadian certification

- CAN/CSA-C22.2 No. 61010-1:2004. Safety requirements for electrical equipment for measurement, control, and laboratory use. Part 1.

Additional compliances

- IEC 61010-1: 2001. Safety requirements for electrical equipment for measurement, control, and laboratory use.

Equipment type

Test and measuring equipment.

Safety class

Class 1 – grounded product.

Pollution degree description

A measure of the contaminants that could occur in the environment around and within a product. Typically the internal environment inside a product is considered to be the same as the external. Products should be used only in the environment for which they are rated.

- Pollution Degree 1. No pollution or only dry, nonconductive pollution occurs. Products in this category are generally encapsulated, hermetically sealed, or located in clean rooms.
- Pollution Degree 2. Normally only dry, nonconductive pollution occurs. Occasionally a temporary conductivity that is caused by condensation must be expected. This location is a typical office/home environment. Temporary condensation occurs only when the product is out of service.
- Pollution Degree 3. Conductive pollution, or dry, nonconductive pollution that becomes conductive due to condensation. These are sheltered locations where neither temperature nor humidity is controlled. The area is protected from direct sunshine, rain, or direct wind.
- Pollution Degree 4. Pollution that generates persistent conductivity through conductive dust, rain, or snow. Typical outdoor locations.

Pollution degree Pollution Degree 2 (as defined in IEC 61010-1). Note: Rated for indoor use only.

Installation (overvoltage) category descriptions Terminals on this product may have different installation (overvoltage) category designations. The installation categories are:

- Measurement Category IV. For measurements performed at the source of low-voltage installation.
- Measurement Category III. For measurements performed in the building installation.
- Measurement Category II. For measurements performed on circuits directly connected to the low-voltage installation.
- Measurement Category I. For measurements performed on circuits not directly connected to MAINS.

Overvoltage category Overvoltage Category II (as defined in IEC 61010-1).

Environmental considerations

This section provides information about the environmental impact of the product.

Product end-of-life handling

Observe the following guidelines when recycling an instrument or component:

Equipment recycling. Production of this equipment required the extraction and use of natural resources. The equipment may contain substances that could be harmful to the environment or human health if improperly handled at the product's end of life. To avoid release of such substances into the environment and to reduce the use of natural resources, we encourage you to recycle this product in an appropriate system that will ensure that most of the materials are reused or recycled appropriately.



This symbol indicates that this product complies with the applicable European Union requirements according to Directives 2002/96/EC and 2006/66/EC on waste electrical and electronic equipment (WEEE) and batteries. For information about recycling options, check the Support/Service section of the Tektronix Web site (www.tektronix.com).

Restriction of hazardous substances

This product is classified as Monitoring and Control equipment, and is outside the scope of the 2002/95/EC RoHS Directive.

Preface

Features and abilities

The Tektronix PA4000 is a powerful and versatile precision power analyzer. Designed to provide clear and accurate measurements of electrical power and energy on all electrical products, the PA4000 is both an easy to use bench instrument and a fast and programmable automatic test interface.

Basic features

- Measures Watts, Volts, Amps, Volt-Amperes and Power Factor. Always accurate, even on distorted waveforms.
- 100 harmonics for voltage, current, and Watts as standard.
- 1 to 4 channels for multiphase measurements.
- Quick access to results, graphing and menus.
- Built in 30 A and 1 A shunt.
- Range of measurement from milliwatts to megawatts.
- Bright color display.
- Comprehensive range of computer interfaces including RS232, USB, GPIB (optional) and Ethernet.
- Data logging to USB memory device.
- ± 15 V supply for external transducers (optional).
- Easy-to-use menu system with context-sensitive help.
- Built in math screen where any result can be manipulated and displayed. Ideal for measurements such as efficiency.

Package contents

The following items are supplied with your PA4000.

Please check that you have every item and report any missing items to your Tektronix supplier as soon as possible.

- PA4000 Power Analyzer chassis containing the analog cards and any other options you ordered.
- Certificate of Conformance and Calibration for each analog card.
- CD, which includes the user manual and calibration data.
- Mains power cable.

- 2 pairs of measuring leads for each analog card.
- 1 USB cable.



WARNING. *To avoid injury, only use safety measuring leads supplied with the PA4000.*

Accessories

Please see www.tek.com for available accessories. These include the following:

- Spare measuring lead set
- A range of current transformers to extend the measuring range from < 1 mA to 1200 A
- Connectors for the 2 mm external shunt input
- Communications leads (RS232, etc.)

Getting started

Before you begin - safety

Carefully read and adhere to the following warning statements before you connect the Power Analyzer.



WARNING. *To avoid possible electric shock or personal injury:*

- *By connecting the Power Analyzer to active circuits, the terminals and certain parts inside the Power Analyzer are live.*
 - *If possible, open the circuit before establishing a connection to the Power Analyzer.*
 - *Before connecting the circuits, ensure that the maximum measuring voltage and maximum voltage to earth ground ($1000 V_{rms}$, CAT II) is not exceeded.*
 - *Do not use leads and accessories that do not comply with relevant safety standards, as this could lead to serious injury or death from electric shock.*
 - *Shunts and conductors can generate heat when in use and surfaces may burn the skin.*
-

Qualified personnel

This product may be operated only by qualified personnel. This means only persons who are familiar with the installation, assembly, connection, inspection of connections, and operation of the analyzer and who have been trained in the following areas:

- Switching on/off, enabling, earth-grounding and identification of electrical circuits and services/systems according to the applicable safety standards.
- Maintenance and operation of appropriate safety gear, in accordance with the applicable safety standards.
- First aid.

Ensure that all persons using the device have read and fully understood the Operators Manual and safety instructions.

Installation

- Mains connection must conform to these ranges/values: 100 – 240 V, 50/60 Hz.
- The device may only be used under certain ambient conditions. Ensure that the actual ambient conditions conform to the admissible conditions specified in this manual.
- Ensure this product is installed in such a way that its power cable is accessible at all times and can easily be disconnected.

- Before each use**
- Ensure that the power and connecting cables as well as all accessories and connected devices used in conjunction with this product are in proper working order and clean.
 - Ensure that any third-party accessories used in conjunction with the device conform to the applicable IEC61010-031 / IEC61010-2-032 standards and are suitable for the respective measuring voltage range.

Connection sequence



WARNING. *To avoid possible electric shock or personal injury:*

When the measuring circuit is used to measure MAINS, the voltage to earth may not exceed 1000 V_{rms} in a CAT II environment.

For safety reasons, when connecting a circuit to the Power Analyzer, proceed in the sequence outlined as follows:

1. Connect the Power Analyzer power cord to a properly grounded mains outlet. The Power Analyzer is now connected to the protective earth ground wire.
2. Power on the Power Analyzer.
3. Connect the measuring circuit according to all instructions and as shown in the connection diagrams in this manual.

- During use**
- For connection work, work in teams of at least two persons.
 - If you detect any damage to the housing, controls, power cable, connecting leads, or connected devices, immediately disconnect the unit from the power supply.
 - If you are in doubt as regards the safe operation of the device, immediately shut down the unit and the respective accessories, secure them against inadvertent switching on, and have them serviced by a qualified service person.

Power on

1. Check the power analyzer is in good condition with no signs of damage.
2. Follow the Connection Sequence described in the Before You Begin - Safety section. (See page 1.)

3. After pressing the power switch at the front to on (I).
 - The PA4000 will start its power up sequence. This takes approximately 15 seconds.
 - During power up you will see the PA4000 serial number and firmware version.
4. The instrument is now ready for use.

Concept of global, group and channel parameters

Definition of a group With a multiphase power analyzer there is often a requirement to link together measurement channels. This is known as grouping. Within a group, one channel will act as the frequency source and reference for all other channels in the group. Grouping is commonly used in applications such as 3 phase motor measurements. Channels 1 and 2 can be grouped together to allow for the measurement of the input power, where channels 3 and 4 could be grouped together to measure the output power. For more information on applying grouping to channels, see the *Wiring* section of *The Menu System* chapter. (See page 44, *Wiring*.)

Global, group and channel settings The PA4000 has many different settings that affect both the appearance of the results and the actual results. To make the instrument easier to operate, settings may have an effect on one or more parameters. Depending on the parameter, the influence or use of it may be on a global level, a per-group level or a per-channel level. The split for parameters that have an effect on measurements and results is defined below.

Global settings Global settings affect all measurements. The following settings are global:

- Blanking (See page 55, *Blanking*.)
- Averaging (See page 56, *Averaging*.)
- Update rate (See page 56, *Update rate*.)
- Auto zero (See page 56, *Auto Zero*.)

Global settings will appear under the System Configuration menu.

Groups settings Per-group settings affect every channel in a group. The settings affected are:

- Measurements (See page 33, *Measurements*.)
- Measurement configuration (that is, number of harmonics, THD, DF and TIF set-up) (See page 37, *Measurements configuration*.)
- Mode (See page 40, *Modes*.)
- Wiring (See page 44, *Wiring*.)

- Ranges(See page 46, *Ranges.*)
- Shunt selection (See page 47, *Shunts.*)
- Frequency source
- Bandwidth (See page 48, *Bandwidth.*)

Channel settings

Channel settings are completely independent of any grouping. The following settings are on a per-channel basis:

- Scaling factor (See page 49, *Scaling.*)

When setting a parameter that is a per-group or per-channel parameter, the group or channel will be displayed at the top of the menu. To change the group or channel, the left and right arrow hard keys are used.

Connecting to the product under test

The PA4000 will measure up to 1000 V_{rms}, CAT II and 30 A_{rms} or 1 A_{rms} directly using the 4 mm terminals on the rear of each analog card. For measurements outside the range (low or high power), see the information on using current and voltage transducers. (See page 26, *Connecting signals.*)

To measure power, connect the PA4000s measuring terminals in parallel with the supply voltage and in series with the load current as shown below.



WARNING. To avoid injury always use good quality safety cables as supplied and check that they are not damaged before use.

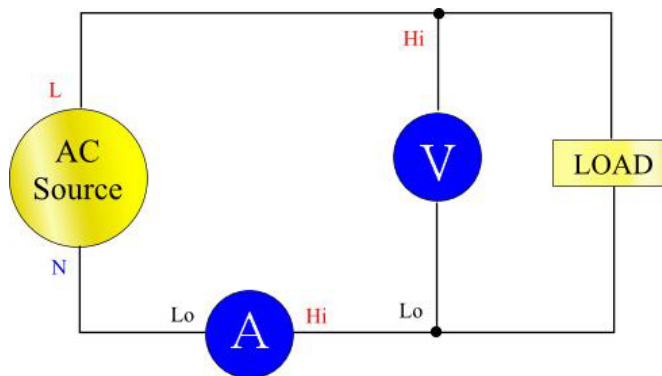



- Connect the AC supply live to the Vhi (1) terminal
- Connect the AC supply neutral to the Vlo (2) terminal
- Connect the load neutral to either the 30 A Ahi (4) or 1 A A1a (6) terminal
- Connect the supply neutral to the Alo (5) terminal

For plug-connected single phase products, the simplest and safest way to make a connection to the product under test is to use a Tektronix Break Out Box. This provides a line socket for connection of the product and 4 x 4 mm sockets for direct connection to the PA4000 terminals as described above.

Default measurements

Switch on the supply to the load and the PA4000 is now ready to make measurements. Note that it is not necessary to switch the PA4000 either off or on when the load is being connected.



The default display shows up to 4 columns of results (one for each channel). The display can be broken down into columns and rows. Each column is one of 4 colors. The color represents which group the results in the column belong to. There can be many different columns within a group. In a single-phase application, there may only be one column of results per group. If the minimum and maximum hold columns were added, then this would expand the number of columns to 3.

Within a group, the result name is listed in the group color on the left of the group. All the results with the group are always shown in the same order. The results are shown on separate rows.

In default mode, each column represents one channel of the instrument, and each channel is contained with a different group. Each group is configured as a wiring setup, for example: 1 phase, 2 wire. Each row clearly shows the measurement type 'Vrms', the measured value, '248.4' and the measurement units, 'V'. Normal engineering notation is used to describe units, e.g. mV = milli-volts (10^{-3}) and MV = mega-volts (10^{+6}).

Navigating the results screen

To scroll through the measurement rows, use the top two soft keys for scrolling and paging up, and use the bottom two keys for scrolling and paging down:



PageUp

Row Up

Row Down

Page Down

To view the results in a larger size, the [ZOOM] key to the left of the display can be used. It will cycle through 3 different zoom levels, which are:

- 4 columns of 12 results per column
- 2 columns of 6 results per column
- 1 column of 3 results per column

If there are more columns to view than can be displayed on the screen at one time (for example: 6 columns of results in 4 column mode), the left and right arrow keys to the left of the display can be used.



The PA4000 has the option of fixed or auto ranging. Default is auto range. If you choose a fixed range, or the peak of the input signal is larger than the range, then an over range condition will occur. This will be indicated on the results screen by all the results in the over ranged channel flashing on and off. In addition, the “Vrms” and / or “Arms” will flash to indicate whether the over range is on either the voltage channel, the current channel, or both.

Navigating the menu system

The menu system provides complete access to all settings of the PA4000. To access the menu system, press the yellow [MENU] key.

To return to the measurement display at any time, simply press the [MENU] key again or press the [RESULT] key.

With the menu system active, the 5 soft keys to the right of the display may be used to navigate and select options. A list of the menu keys can be found in the soft key section of the manual. (See page 21, *Soft keys*.)









If the menu you are in displays a group or channel name, this means that the setting is only for the displayed group or channel. To move to another group or channel, use the left and right arrow keys.



Example: Choosing measurements to display

One of the first tasks that a user may want to carry out is change the list of measurements that are displayed.

To choose the measurements on the display:

1. Press [MENU] (to show the menu)
2. Press  to see the list of Measurements. Measurements with a  will be displayed in the order shown.
3. Use the  and  keys to select a measurement to display and press  to enable it to be displayed.
4. If you want to change the order in which a measurement is shown, first select the measurement you want to move and then press . The selection bar will turn red.
5. Use  and  to move the measurement and then press  to accept the new position.

To remove a selected measurement, select it and press .

Hint:

To restore the default list, see the User Configuration Menu. (See page 57, *User configuration.*)

NOTE. *Depending on the mode selected, some measurements will not be selectable. (See page 40, Modes.) More details on selecting measurements are available. (See page 33, Measurements.)*

On screen help

Throughout the menu system on screen help is available to provide the user with summarized help on the subject at hand. As an example, press the [MENU] button and then press the [HELP] button and help on the main menu will be displayed. Press the [HELP] button again to remove the help and return back to the previous screen.

As the user tunnels through the menu system and requires help on a particular screen, simply press the [HELP] button to get a brief summary of help on that subject. Help does not exist on every screen and at every level therefore if the [HELP] button is pressed without any help showing then there is no help available at this level.

Front panel operation

Front panel layout

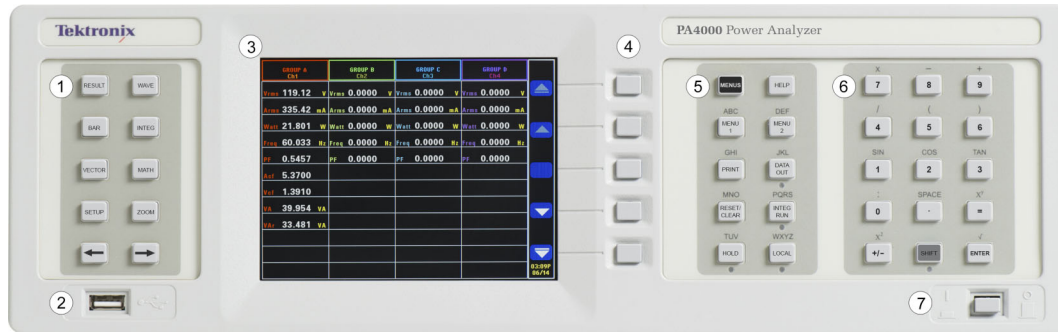

1. Quick View buttons
2. Easy-to-reach USB connection for memory devices (optional Ethernet / USB card is required)
3. 640 x 480 TFT display
4. 5 soft keys
5. Operational and Alphabet buttons
6. Number and Equation buttons
7. Front mounted on / off switch.

Quick view buttons

To the left of the display are the quick view buttons. These allow easy access to various different displays.

The first 7 keys change the display screen to show different information:

- [RESULT] - Displays the normal results screen
- [WAVE] - Displays waveforms
- [BAR] - Display harmonics bar chart
- [INTEG.] - Displays integrator waveforms
- [VECTOR] - Displays a vector diagram
- [MATH] - Displays the math results as configured from the math menu
- [SETUP] - Displays a screen showing the current configuration of the unit

Pressing any one of these keys will change the display to the appropriate display. Pressing it again will have no effect.

At the bottom there is a [ZOOM] key, and left and right arrow keys.

The zoom key will change the number of results displayed on the screen. It will go from 4 columns, to 2 columns and then to 1 column. Pressing again will return the display to 4 columns.

The left and right arrow keys will move the results left and right to enable the user to see more results (there can be up to 15 columns of results). The left and the right arrow keys are also used in other screens such as the menu screen for changing groups or the waveform screen for moving the cursors.

Results screen The results screen is the default, power on screen for the PA4000.



The results screen displays all the requested results.

The size / number of results on the screen can be control by using the ZOOM key.

The actual results displayed, along with the order in which they are displayed, is controlled by the [MEASUREMENTS] menu. (See page 33, *Measurements.*) Also, the number of harmonics displayed, the minimum and maximum hold columns displayed, and the display of the SUM column are controlled using the [MEASUREMENT CONFIGURATION] menu.(See page 33, *Main menu.*)

Waveform screen The waveform key will show waveforms of the measured data in continuous operating mode.

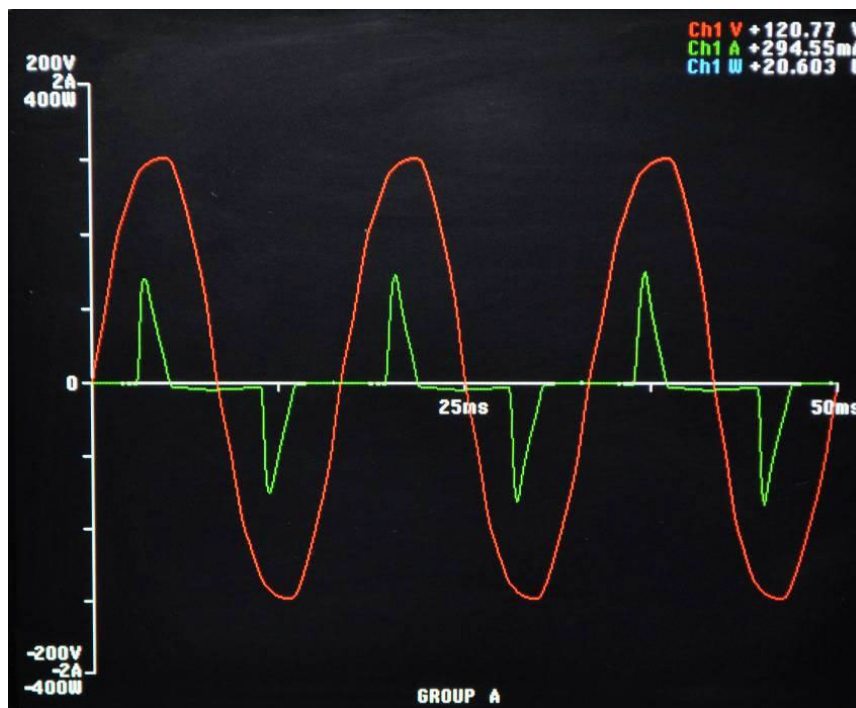

The waveform screen consists of two sections. At the top right of the display are the Volts, Amps and Watts values for each of the channels in the group. The label for the channel is color coded to match the waveform. (See page 50, *Graphs and waveforms*.) Measurements are displayed even if the waveform is not.

Below these measurements is the actual waveform which is plotted out against an x and y axis.

Waveforms can be viewed by pressing the [WAVE] button to the left of the display. Waveforms for viewing can also be selected by pressing [MENU] and selecting Graphing and Waveforms and then Waveforms followed by the actual selection of Vrms, Arms, or Watts to display as a waveform.

Waveform selection is done on a per-group basis. This means that only signals within a specified group can be displayed on the same waveform graph.

Changing the group is done by using both the left and right arrow keys to the bottom left of the display. This will change both the group for waveform selection and the waveforms displayed.

When drawing a waveform, the phase reference signal for the group is started at the intersection of the X and Y axis. Choosing to display or not display the reference waveform will not affect the position of the other waveforms. For example, if channel 1 volts was the phase reference and channel 1 amps was 90 degrees lagging, but channel 1 volts was not displayed, then channel 1 amps would still start at 90 degrees lagging.

For the x (time) axis, the range will be twice the period of the lowest frequency signal being displayed, rounded up to time starting with 1, 2 or 5. For example, if 50 Hz were the lowest frequency, then twice the period would be 40 ms, and so 50 ms would be the time base. If there is no frequency measured on any of the displayed waveforms (i.e. all DC) then 500 ms will be used for the time base.

For the y axis the range for all the channels being displayed of the same units (Volts or Amps or Watts) is examined. The maximum range is the range used.

Barchart screen

The bar chart displays either Volts, Amps or Watts harmonic information in the form of a bar chart.

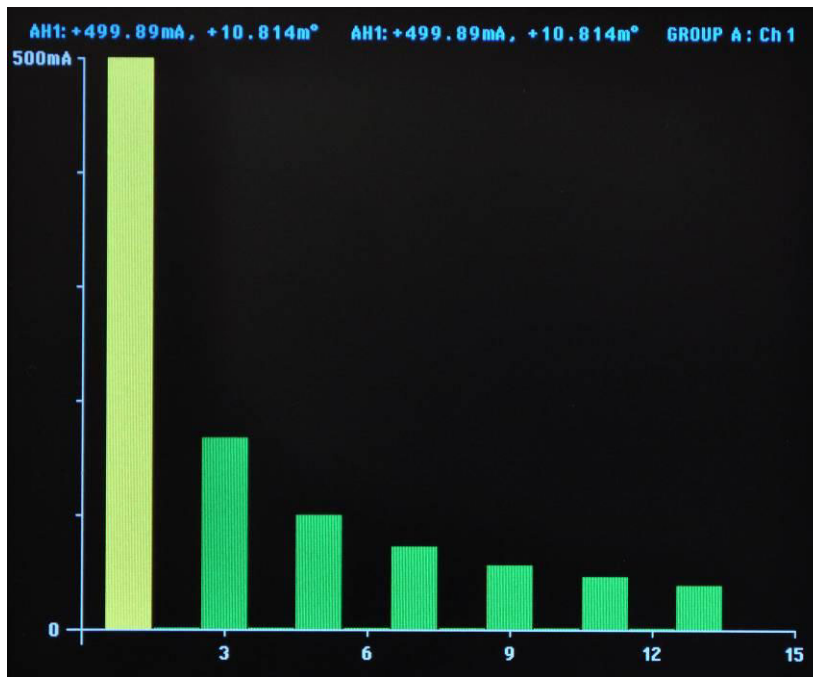

The data used for the display is based on the harmonics setup for the group in which the channel is in. All soft key actions are on a per-group basis. The left and right hard arrow keys are used to change channel (← →).

Harmonics do not need to be displayed as results for the bar chart to show harmonics. If harmonics is never displayed, and never configured, then the bar chart would be based on the default harmonic setup.

At the top of each graph are 2 readings. The first is the fundamental value, in the measured units, and phase angle. The second result is the highlighted harmonic in the same units as it would be displayed on the results screen (either percentage or absolute as defined by the users setting for the group) and the phase angle. The phase angle will be displayed irrespective of whether it is displayed on the results screen.

Next to the 2 readings is text stating the group and the channel that the bar chart reflects.

An individual harmonic can be selected by using the left and right arrow soft keys. The selected harmonic will be yellow as opposed to green. The left and right arrows will only change the selection of the harmonic with the active group. If the display is only showing one bar chart, then using the selection is straightforward. When the user then changes to the next channel using the left and right hard keys, the harmonic selected will be based on possible changes when viewing the previous channel.

For the x axis, the maximum number of harmonic values that can be displayed is 50, even though there could be up to 400. The harmonic values displayed are determined by the harmonic sequence and range for the appropriate group. For example, if the unit has been configured to display odd and even harmonics up to the 50th, then 50 harmonics will be displayed. If only odd harmonics up to the 19th, then 10 harmonics will be displayed.

If the number of harmonics to be displayed is less than 50, then they will be spread across the allowed width of the graph. If the user has selected more than 50 harmonics to display, then the left and right arrow soft keys will be used to scroll through the harmonics and the axis labels will be changed after the 50th harmonic result has been reached.

A summary of the soft keys is detailed below:



Toggles the harmonics displayed between Volts, Amps and then Watts, returning back to Volts. Works on a per-group basis.



Changes the harmonic selected by one to the right (higher order).



Changes the harmonic selected by one to the left (lower order).



Jumps to the harmonics setup menu.

Integrator screen The integrator screen allows you to display integrated results on a graph. (See page 41, *Integrator mode*.) One of the following results can be displayed at any one time:

1. Watt Hours
2. VA Hours
3. VAr Hours
4. Amp Hours
5. Watts Average
6. PF Average
7. Volts
8. Amps
9. Watts
10. Fundamental VA-Hours (VAHf)
11. Fundamental VAr-Hours (VArHf)
12. Correction VArS

As with the integrator itself, the results are displayed on a group-by-group basis. This means that the maximum number of plot lines is 4, which will occur in a 3p4w system with SUM results. There is the option of adding or removing plot lines from the display within the constraints of the group. For example, you could select to see the channel 1 result and the SUM result. There are two reasons for allowing this selection. Firstly, in a balanced three-phase system, the integrated readings for each channel will be very similar and so the plot lines will be overlaid one on top of the other. This could lead to confusion. Secondly, again in a balanced three phase system, if a channel and the SUM results are displayed on the same graph, the channel plot will never come higher up the y axis than 1/3 way, at best. Removing the SUM result and rescaling the y axis) allows better resolution for the channel plot.

At the top of the display is a reading for each channel in the group (including the SUM channel). The reading is for the same result as is selected in the integrator waveform setup screen to display on the screen i.e. if the plot is WHrs, then the reading is WHrs.

The plot is always in the same color as the channel designator.

At any time while the integration graph is being displayed, pressing the left or right arrow hard keys will change to group results. If only one group is in integrator mode, then graph will not change.

Both the x and y axis are automatically scaled. For the y axis, the time will change automatically as the integration time increases. This allows for the best viewing of the graph.

Any time during integration, you change the plots by pressing the [INT] soft key. This will take the user directly to the integrator waveform setup menu with the appropriate group selected.

Vector screen The vector diagram displays one of Volts, Amps or Volts and Amps harmonic information in the form of a vector diagram.

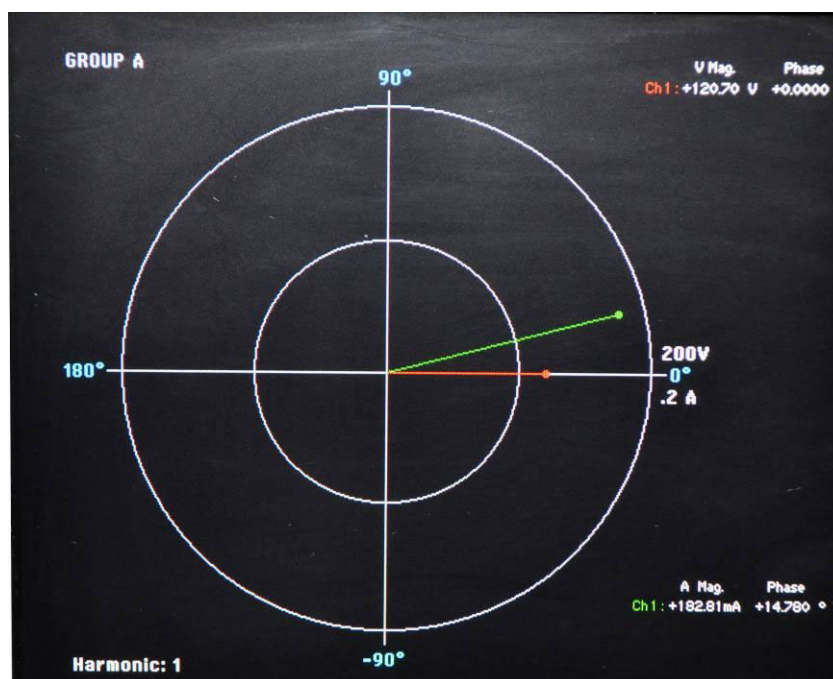

Vectors will be displayed on a per group basis. The left and right hard keys to the left of the display will be used to change the currently displayed group. The active group is displayed in the top left corner in the appropriate group color.

The left and the right soft keys will be used to change the harmonic number currently being displayed. The harmonics available for display will be the same as the harmonics in the results screen. There are two differences. The first is that if the results screen is configured to display magnitudes as a percentage of the fundamental, the absolute magnitude will still be used. This will allow a true comparison between the magnitudes of the selected harmonic for each channel in the group. The second is that if the user has not enabled harmonics to display, then the harmonic setup will still be used. This therefore provides a quick way to view harmonic information without displaying harmonics.





The [V/A] top soft key toggles the display between displaying Volts vectors only, Amps vectors only and both Volts and Amps vectors.

Each vector displayed is shown in a different color. There can be up to 6 vectors displayed on the graph at one time. This would be a for a 3p4w configuration showing Volts and Amps.

In addition to displaying a vector line, the magnitude and phase angle of the vector are displayed to the right of the vector diagram. Both the voltage and current information is shown even if the vector is not.

The magnitude is based on the maximum range for the group being displayed (in auto range channels can be on different ranges). The ranges will not change when the harmonic number is changed, allowing a visual comparison between harmonic numbers.

A summary of the soft keys is detailed below:

	Toggles the vectors displayed between Volts only, Amps only and Volt and Amps together. Works on a per-group basis.
	Changes the harmonic vector displayed by one to the right (higher order). Works on a per-group basis.
	Changes the harmonic vector displayed by one to the left (lower order). Works on a per-group basis.
	No action.
	Jumps to the harmonics setup menu. Jumps to the appropriate group.

Math screen

The Math screen is used to display user configured values. These could simply be a selection of desired values displayed on one easy-to-read screen, or basic measurements mathematically manipulated to show a required a value.

Math			
CH1VRMS	120.71 v	FN2	0.0000
FN3	0.0000	FN4	0.0000
FN5	0.0000	FN6	0.0000
FN7	0.0000	FN8	0.0000

Up to 30 math functions, labelled FN1 through FN30, can be defined. For each function the following can be specified:

- Name – User friendly name up to 10 characters. (Default is the same as the label i.e. FN1). In the menus, the function label is always displayed alongside the users name for the function.
- Units – User friendly units such as W for Watts. (Default is blank). Scaling such as u, m, k, M will be added to the unit as appropriate. Units will be up to 4 characters.
- Equation – The actual math formula, up to 100 characters.

For additional information see Math.(See page 52, *Math.*)

Setup screen

The setup screens are accessed by pressing the [SETUP] button. There are two screens. The first screen displays the current configuration of the channels and groups, and also items such as blanking and comms settings.











Analyzer Configuration				
	Channel 1	Channel 2	Channel 3	Channel 4
V Scaling	1.000	1.000	1.000	1.000
I Scaling	1.000	1.000	1.000	1.000
Ext.Shunt Scal.	1.000	1.000	1.000	1.000
V Ext.Phase Comp.	0.000	0.000	0.000	0.000
I Ext.Phase Comp.	0.000	0.000	0.000	0.000
V Range	200V	200V	200V	200V
I Range	1A	1A	1A	1A
	GROUP A	GROUP B	GROUP C	GROUP D
Wiring	1 Phase 2 Wire	1 Phase 2 Wire	1 Phase 2 Wire	1 Phase 2 Wire
Mode	Normal	Normal	Normal	Normal
V Range	200V	200V	200V	200V
I Range	1A	1A	1A	1A
Shunt	Internal(30A)	Internal(30A)	Internal(30A)	Internal(30A)
Freq. Source	Volts	Volts	Volts	Volts
Phase Ref.	Volts	Volts	Volts	Volts
Freq. Range	10Hz - 50kHz	10Hz - 50kHz	10Hz - 50kHz	10Hz - 50kHz
Bandwidth	High	High	High	High
Press -> for instruments information				



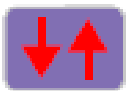

The second screen shows instrument configuration including information such as when the unit was last verified and last adjusted, the serial number of the unit and the firmware version, and information on the installed analog cards.

Analyzer Configuration				
Serial Number	100010200012			
Firmware version	1.000.036			
Language	English			
	Serial Number	Hardware Rev.	Last Verified	Last Adjusted
Main Card	090018500027	7		
Channel 1	090018100077	6	03-30-2012	05-03-2012
Channel 2	090018100093	6	03-30-2012	05-03-2012
Channel 3	090018100085	6	03-30-2012	05-03-2012
Channel 4	090018100070	6	03-30-2012	05-03-2012
Press <- for user information				

Soft keys

Soft keys are used to provide context sensitive functionality. Through the many screens, common soft key images are used to provide common functionality. The common soft keys are shown below. If the symbol on the key is grey, then it means that you have reached the limit of that key. For example, if you are at the top of the results, then the up arrow will be grey. Details on the specialized soft keys are in the appropriate section of the manual.

	Page up
	Move up one result / menu line / help text line
	No functionality
	Move down one result / menu line / help text line
	Page down
	Tunnel up to the previous menu
	Tunnel down to the selected menu
	Move the selected measurement up or down in the list
	Move selected measurement up one row
	Move selected measurement down one row
	Select highlighted item

	Cancel
	Save result
	Delete one character to the left of the cursor
	Clear the text entry

Operational and alphabetical buttons

To the right of the soft keys are the operational keys, which also function as a way of entering alphabetical characters.

- [MENUS] – Toggles the on screen menus on and off. The menu will always come on at the top level.
- [HELP] – Toggles on screen help that is context sensitive based on the current display. Pressing any other key, other than configured soft keys, when help is displayed, will have no effect. Pressing [HELP] again will remove the help screen.
- [MENU 1] / [ABC], [MENU 2] / [DEF] – These keys provide quick access to a set menu. Pressing and holding either of these keys for 2 seconds while displaying a menu will link the menu to the pressed key. For example, if you press and hold [MENU 1] while the Voltage range menu is showing, then pressing [MENU 1] while any other screen is showing will display the Voltage range menu.
- [PRINT] / [GHI] – Send the displayed results to the designated printer / device which can be either a USB printer, an RS232 printer or a memory stick. NOT YET IMPLEMENTED.
- [DATA OUT (DATA DUMP)] / [JKL] – Pressing this key will start or stop a data log. If data is being logged, then the LED under this key will be flashing.
- [RESET / CLEAR] / [MNO] – The function of this key will be dependent on the configuration of the instrument. It can clear minimum / maximum hold results and reset the integrator.
- [INTEG. RUN] / [PQRS] - Pressing this key will start or stop the integrator. If the integrator is running, then the LED under this key will be flashing.

- [HOLD] / [TUV] – If pressed, the results stop updating on the screen. Pressing again lets the results change. If the display is held, then the red LED below the [HOLD] key will be illuminated. If the integrator is running, the values will still be accumulating.
- [LOCAL] / [WXYZ] – Any time the instrument receives communications via USB, GPIB, Ethernet or RS232, the front panel will be locked out. Pressing the [LOCAL] key will return control to the front panel. When the front panel is locked out, the yellow LED beneath the [LOCAL] key will be lit.

Each of the above keys also has an alternative function, which is highlighted in blue. To access these functions, the [SHIFT] key has to be pressed. Basically this will give access to letters for text entry within the menus. Each time the same key is pressed the letter being entered will be changed in the order shown above the key. If the key is not pressed for 1 second, or a different key is pressed, the cursor will move to the next position.

Number and equation buttons

The main purpose of the numeric section of the keypad is for numeric and equation entry. The keys are as follows:

- [7] / [x] - Number seven or, with [SHIFT], multiply.
- [8] / [-] - Number eight or, with [SHIFT], subtract.
- [9] / [+] - Number nine or, with [SHIFT], add.
- [4] / [/] - Number four or, with [SHIFT], divide.
- [5] / [(] - Number five or, with [SHIFT], left parentheses.
- [6] / [)] - Number six or, with [SHIFT], right parentheses.
- [1] / [SIN()] - Number one or, with [SHIFT], SIN function.
- [2] / [COS()] - Number two or, with [SHIFT], COSINE function.
- [3] / [TAN()] - Number three or, with [SHIFT], TAN function.
- [0] / [:] - Number zero or, with [SHIFT], a colon).
- [.] / [SPACE] - Decimal point or, with [SHIFT], space.
- [=] / [xy] - Equals or, with [SHIFT], X to the power Y.
- [+/-] / [x2] - positive or negative or, with [SHIFT], x squared.
- [SHIFT] - Enable the blue shift options on both the numeric and general keys.
- [ENTER] / [√] - Enter or, with [SHIFT], square root.

Logging data to a memory device

The PA4000, can be used to log data to a USB flash drive. The unit will log all selected measurements into a comma separated value (CSV) formatted file that is stored on the connected USB flash drive. Results will be logged once per second.

Prior to enabling data logging, insert a USB flash drive into the USB host port on the front of the PA4000. The rear port cannot be used for flash drives.



CAUTION. *If the USB flash drive is removed while data logging is enabled, data corruption will occur.*

Logging data

To start data logging press the [DATA OUT (DATA DUMP)] key. The LED beneath the key flashing every second will indicate data logging. To stop data logging, press the [DATA OUT (DATA DUMP)] key. Once the LED goes off, the drive is safe to remove.

Data storage and format

The data will be logged in a directory created by the PA4000 on the USB flash drive. The directory structure created will contain the last five digits of the serial number of the PA4000 used and the date at the start of data logging. The file name will reflect the time at the start of data logging in 24 hr format and will have a .CSV extension.

For example, if a PA4000 with the serial number 100010200001 begins data logging on 31 December 2011 at 2:18:56 PM, the directory tree will be as shown below.

```
Root Dir\ PA4000 \00001\11-12-31\14-18-56.csv
```

The first portion of the file will contain a header identifying the instrument used by serial number and the time data logging began.

The second portion will contain information on the group configuration of the PA4000. It will contain the group index, the name of the group, the number of channels in the group, and the number of results returned for the group.

The third portion of the file will contain column headers for every measurement currently selected. Subsequent columns will contain an indexed set of the measurements currently selected, in the order displayed on the PA4000 screen. An example of the data returned is shown below.

	A	B	C	D	E	F	G	H	I
1									
2	Serial Nur	100008200001							
3	Firmware	1.000.028							
4	Start Date	10/16/2011							
5	Start Time	10:43:03							
6									
7	Group	Name	# of Ch.	# of Res.					
8	1	GROUP A	1	6					
9									
10									
11	Index	Time	Vrms	Arms	Watt	Var	Freq	PF	CH1VRMS(V)
12	1	10:43:04	1.10E+02	1.96E-01	1.19E+01	1.78E+01	6.00E+01	5.57E-01	1.10E+02
13	2	10:43:05	1.10E+02	1.96E-01	1.20E+01	1.78E+01	6.00E+01	5.58E-01	1.10E+02
14	3	10:43:06	1.10E+02	1.96E-01	1.20E+01	1.78E+01	6.00E+01	5.58E-01	1.10E+02
15	4	10:43:07	1.10E+02	1.96E-01	1.20E+01	1.78E+01	6.00E+01	5.58E-01	1.10E+02
16	5	10:43:08	1.10E+02	1.96E-01	1.20E+01	1.78E+01	6.00E+01	5.58E-01	1.10E+02
17	6	10:43:09	1.10E+02	1.96E-01	1.20E+01	1.78E+01	6.00E+01	5.58E-01	1.10E+02
18	7	10:43:10	1.10E+02	1.96E-01	1.20E+01	1.78E+01	6.00E+01	5.57E-01	1.10E+02
19	8	10:43:11	1.10E+02	1.96E-01	1.20E+01	1.78E+01	6.00E+01	5.57E-01	1.10E+02
20									

Math results are also returned when data logging. These will be after the channel results. Only enabled math results will be returned. The column name will consist of the function name and the units specified by the user.

For additional information, see USB Host(See page 99, *USB host.*)

Connecting signals

Input overview



WARNING. To avoid possible electric shock or personal injury:

· Do not touch connections, internal circuits or measuring devices that are not connected to earth ground.

· Always adhere to the instructions regarding the sequence of connection (See page 2, Connection sequence.)

Signals are connected to the PA4000 on the rear of the PA4000. There are multiple inputs for each analog card as shown below.



1. Voltage high connection
2. Voltage low connection
3. T1AH, 250 V fuse to protect the 1 A shunt
4. 30 A current high connection

5. Current low connection (common to both the 30 A and 1 A shunt)
6. 1 A current high connection
7. External shunt current input high
8. External shunt current input low
9. ± 15 V supply for powering external transducers (optional)

Voltage Voltages of up to $1000 V_{\text{rms}}$ may be connected directly to the black and yellow 4 mm VHI and VLO safety sockets at the rear of the PA4000.

Current The PA4000 has two built-in current shunts. The shunt first allows currents of up to $30 A_{\text{rms}}$, 200 A peak to be connected directly to the black and yellow 4 mm AHI and ALO safety sockets at the rear of each measurement channel of the PA4000. The second shunt allows up to $1 A_{\text{rms}}$, 5 A peak to be connected directly to the blue 1A and blue safety sockets also on the rear of each measurement channel.

External current inputs The external current inputs accept a voltage of up to ± 3 V peak that is proportional to the current being measured. This input allows a very wide range of external current transducers to be connected, from low milliamp current shunts to mega-Amp current transformers. For each type of transducer, the PA4000 may be scaled to read the correct current. (See page 44, *Inputs*.)

The choice of current transducer will depend on:

- The current being measured, including peaks and transients.
- The accuracy required.
- The bandwidth required: Unless the waveforms are purely sinusoidal, a bandwidth in excess of the fundamental frequency will be required.
- Whether there is DC current present.
- Convenience of connection – that is, using a clamp-on current transformer, with jaws that open, for quick connection in a fixed wiring loom.
- The effect of the transducer on the circuit.

To connect a simple current transformer

To use a conventional current transformer (CT) like the Tektronix CL series (or any other transducer with a current output), connect the normal AHI and ALO inputs of the PA4000 to the outputs of the current transformer. Follow the manufacturers instructions for the safe use and installation of the transducer. Depending on the output level of the current transformer, you will need to choose between the 30 A AHI input and the 1 A AHI input. The choice will be dependent on the dynamic range of the output of the current transformer that you are expecting.

Normally the positive or HI output of the transducer will be marked with the point of an arrow or a + symbol. Connect this terminal to the appropriate AHI input of the PA4000.

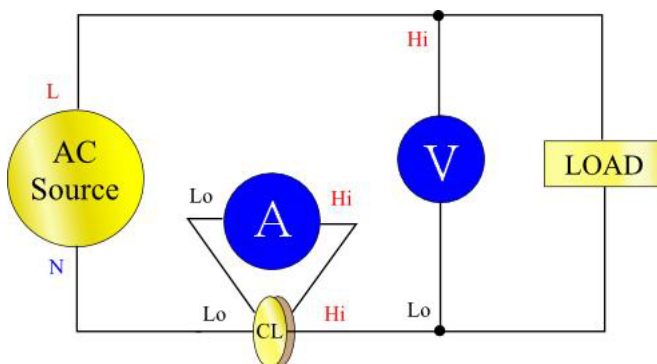

Current scaling

A current transformer produces an output current that is proportional to the load current being measured. For example, the Tektronix CL200 produces an output current that is 1/100 of the current being measured.

To measure the correct current on the PA4000, use the scaling function of the analyzer to scale, or multiply, the CT output current.

For example, the CL200 is a 100:1 CT. When measuring 100A, its output is 1A. To scale this on the PA4000, a scale factor of 100 must be entered:

Press [MENU]

Select 'Inputs' and press

Select 'Scaling' and press

Select 'Amps' and press

Use the key to clear the entry.

Type the new scale factor (100)

Press

Press [MENU] to return to the measurement display.

The PA4000 is now ready to make measurements using a CT.

To connect an external resistive shunt

Using a resistive shunt is a straightforward method of extending the current measuring range of the PA4000. The shunt resistor is connected in series with the load and the voltage across the shunt is directly proportional to current.

That voltage may be connected directly to the External Current Inputs of the PA4000.

For example, a 1 milliohm shunt is used to measure 200 A rms.

1. Check that the voltage that will be generated is suitable for the PA4000

$$V = I \times R \text{ (Ohm's law)}$$

$$V_{\text{shunt}} = I \times R_{\text{shunt}}$$

$$V_{\text{shunt}} = 200 \times 0.001 \text{ Ohms}$$

$$V_{\text{shunt}} = 0.2 \text{ V}$$

This is well within the 3 Vpk rating of the PA4000's External Current Inputs

2. Connect the shunt in series with the load and to the EXT-HI and EXT-LO inputs as shown.

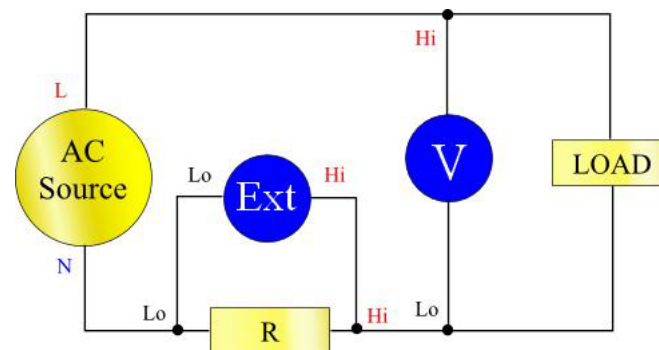

Remove any connections to the normal ALO terminal!





WARNING. Connections to the normal AMPS terminals can have high voltage on them.



To avoid errors and a risk of electric shock, remove all connections to ALO. EXT-LO and ALO are connected inside the PA4000 and so connections to AHi, ALo and AIA can have the same potential as EXT-LO.



For the best noise immunity EXT-LO should be connected directly to ALO.

3. Set up the PA4000 to measure current from the EXT-HI and EXT-LO terminals. Press 'MENU'

Press [MENU]

Select   'Inputs' and press 

Select   'Shunts' and press 

Select   'External' and press 

Press [MENU] to return to the measurement display.



4. Scale the measurement on the display.



The default scale is 1 V = 1 A.



In this example where $R = 0.001$ Ohms. The scaling factor is specified in Amps per Volt, so in this case, the scaling factor is 1000.

To enter a scale factor for current:

Press [MENU]

Select   'Inputs' and press 

Select   'Scaling' and press 

Select   'External Shunt' and press 

Use the  key to clear the entry.

Type the new scale factor (100)

Press 

Press [MENU] to return to the measurement display.

The PA4000 is now ready to make measurements using an external shunt.



To connect a transducer with a voltage output



These transducers contain active circuits that help to improve performance at high bandwidth. They may be of the 'hall effect' or Rogowski coil type.

The procedure is similar to that of installing an external shunt as described above.

1. Follow the manufacturer's instructions for the safe use and installation of the transducer.
2. Connect the voltage output to the EXT-HI and EXT-LO terminals of the PA4000 channel as above.
3. Select 'Inputs' – 'Shunts' – 'External' as above.

Press [MENU]

Select   'Inputs' and press 



Select   'Shunts' and press 



Select   'External' and press 



Press [MENU] to return to the measurement display.

- Select and input a scale factor. These types of transducers are often rated in terms of mV / amp. For example a transducer with an output of 100mV / amp is the equivalent of a 100 milliohm external shunt resistor. To convert the rated scaling from Volts per Amp to the desired Amps per Volt, invert the value. Using the above example, 100 mV / Amps is equivalent to 10 Amps / Volt.

Press [MENU]

Select   'Inputs' and press 

Select   'Scaling' and press 

Select   'External Shunt' and press 

Use the  key to clear the entry.

Type the new scale factor (such as 0.1)

Press 

- Press 'MENU' to return to the measurement display.

The PA4000 is now ready to make measurements using a current transducer with a voltage output.

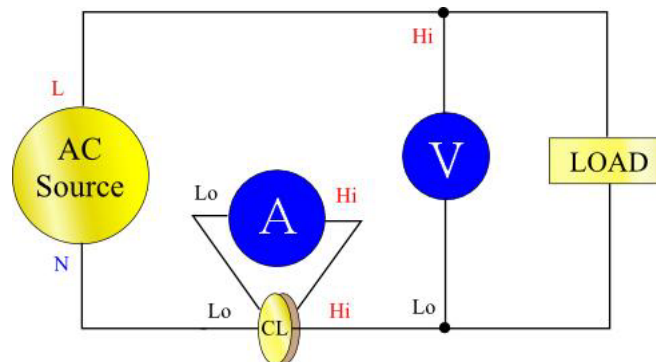

To connect a voltage transformer / transducer

The PA4000 may be used with a voltage transformer (VT) or other transducer to extend its measuring range. Follow the manufacturer's instructions for the safe use and installation of the transducer.

The output of the transducer is connected to the normal VHI and VLO terminals. Normally the positive or HI output of the transducer will be marked with the point of an arrow or a + symbol. Connect this terminal to the VHI input of the PA4000.



Voltage scaling



A voltage transformer (VT) produces a voltage output, which is proportional to the voltage being measured.

To measure the correct voltage on the PA4000, use the scale function of the analyzer to scale, or multiply, the VT output current.

For example, when measuring with a 1000:1 VT a scale factor of 1000 must be used.

Press [MENU]

Select   'Inputs' and press 

Select   'Scaling' and press 

Select   'Volts' and press 

Use the  key to clear the entry.

Type the new scale factor (1000)

Press 

Press MENU to return to the measurement display.

The PA4000 is now ready to make measurements using a VT.

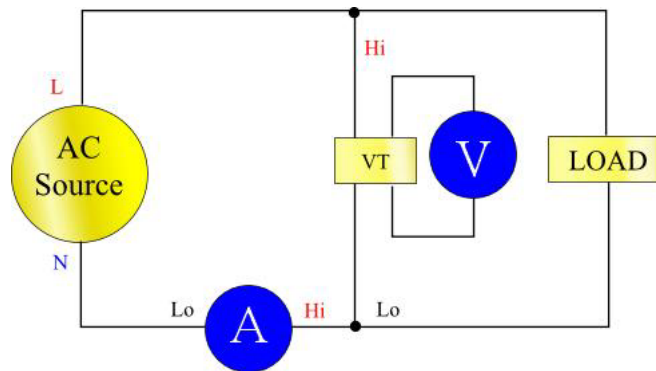

Power for external transducers

The PA4000 can have an optional ± 15 V power supply for the purpose of providing power to external transducers. The supply is capable of supplying 250 mA per rail on each analog card (250 mA on +15 V and 250 mA on -15 V). The connector is conveniently placed next to the inputs on each analog.

If the ± 15 V supply option is purchased, then 4 mating connectors (Tektronix part number 56-598) will be provided to aid in making a connection. These connectors are Wago 231-303/026-000.

The menu system

Navigation

The PA4000's menu is a powerful yet easy-to-use system for control of the analyzer. See the *Quick Start* section of this manual for an overview of how to access and use the menu system. (See page 8, *Navigating the menu system*.)

For help at any time while using the PA4000 press the HELP key at any time.

Menu items

To switch the display of the menu system off or on, press the 'MENU' key at any time.

Main menu

To select a menu, press the MENU key.

Measurements

Default: V_{rms} , A_{rms} , Watt, VA, PF, and Freq.

The user can set the order in which the measurements appear on the screen. This is on a per-group basis. The measurements, on a group-by-group basis, can be displayed in any order, including harmonics. However, harmonic results will always be displayed as a block i.e. all the Voltage harmonics will be displayed as a continuous block based on the parameters set.

A normal measurement screen is shown below:

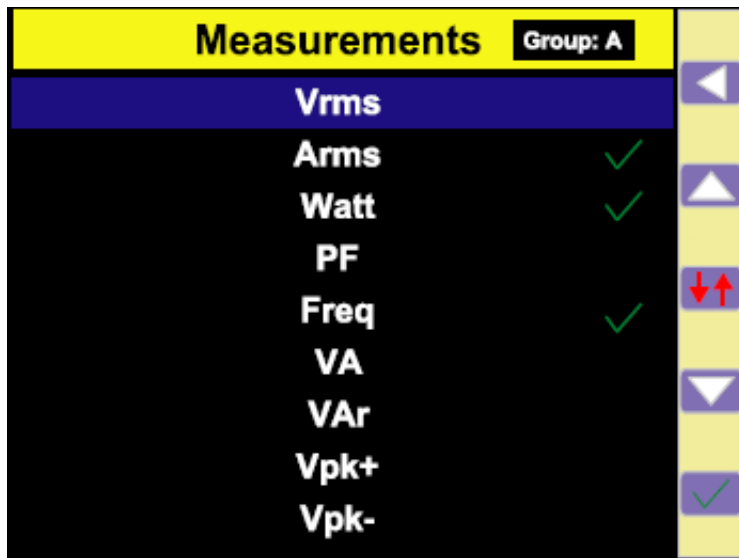

On the measurements screen you will both be able to select a measurement to be displayed as a result and also change the order in which the results are displayed. When you enter the measurement screen you will have the following soft keys available:







Tunnel Up



Selection Up or top of list



Move Measurement

	Selection down or bottom of list
	
	Select measurement to be a result on the screen or de-select measurement
or	
	

To navigate to a desired result, use the up and down arrow soft keys. The current selection will be shown by the measurement highlighted in blue.

If a result is selected, then it will have a green check mark at the right hand edge of the list. If it is not selected, then there will be no check mark.

The results screen shows all the selected results, in the order in which they appear in the measurement list, remembering that the list only applies to the group selected.

NOTE. *Unless the group is in Integrator mode, integration measurements cannot be selected. These measurements are:*

Hours
Watt-Hours
VA-Hours
VAr-Hours
Amp-Hours
Average Watts
Average PF
Corrected VAr
Fundamental VA-Hours (VAHf)
Fundamental VAr-Hours (VArHf)

If you need to change the order of the results, then you should navigate to the desired result and then click the “Move Measurement” soft key. When the move measurement key is pressed, the highlight bar will change from blue to red.

The soft keys will then change as shown below:



Tunnel Up. The move is cancelled, and the user will return to the main menu screen.



Move selected measurement up (gray if at the top of the list already).



Cancel the move, and put the measurement back where it was before the move was started.



Move selected measurement down (gray if at the bottom of the list already).



Place the measurement in the selected position. The soft keys will change back to the standard measurement screen keys.

An example of a measurement being moved is shown below:

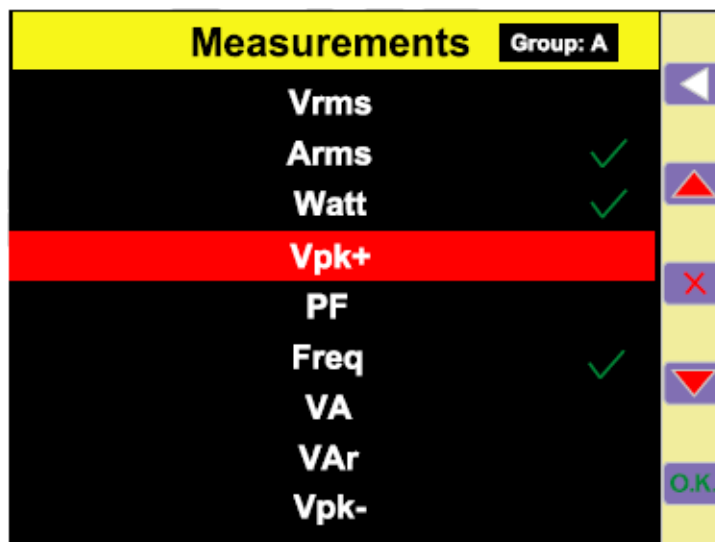

Measurements configuration

The measurement configuration menu contains menus to set up Volts and Amps harmonics as well as Volts and Amps THD, DF and TIF readings. These measurements are selected in the measurement menu. In addition, the measurement configuration menus allow the selection of the SUM channel column and the minimum and maximum hold columns.

The top-level menu consists of the following:

- Harmonics Setup
- Distortion Setup
- Minimum Hold Column
- Maximum Hold Column
- SUM Column

Harmonics setup

Under the harmonics menu item there are separate voltage, current and Watts menus that allow the setting of the following:

- Harmonic Sequence - Odd and even or odd harmonic only (default Odd and even).
- Range – 1 to 100 (default 7)
- Format – Absolute or percentage of fundamental (default Absolute)
- Display Phase Angle – On or off (default On) (Volts and Amps only)

The selection of harmonics results to display has no impact on the harmonic data used in distortion calculations.

Please see the User Configuration section of this manual about update speed. (See page 57, *User configuration*.) The instrument is not able to calculate and display 100 harmonics on V, A and Watts every 100 ms.

Distortion setup

Under the Distortion Setup line item there will be separate menus for Vdf (Distortion Factor), Vthd (Total Harmonic Distortion), Vtif (Telephone Influence Factor), Adf, Athd and Atif.

Distortion Factor. The Distortion Factor formula (previously called the Difference Formula) includes the effects of high frequency and noise. This equation only produces a valid number if the RMS is not less than the fundamental. If the fundamental is larger than the RMS the display shows '—'.

The equations are:

$$Vdf = \frac{1}{V_{ref}} \sqrt{V_{rms}^2 - V_{h_{01}}^2} \times 100\%$$

and

$$Adf = \frac{1}{A_{ref}} \sqrt{Arms^2 - Ah_{01}^2} \times 100\%$$

The reference value can be either the fundamental reading or the rms reading. The default reference is the fundamental value.

Total Harmonic Distortion (THD). THD (Total Harmonic Distortion) is a measure of the distortion of a waveform.

Under the V and A Total Harmonic Distortion factor (THD) measurement menus is the ability to set the following parameters:

- Harmonic Reference – Fundamental or RMS (default Fundamental).
- Harmonic Sequence - Odd and even or odd harmonic only (default is odd and even).
- Range – 2 to 100 (default 7). This is the last harmonic used in the calculation. If odd only harmonics are specified and Range is set to an even number, then the preceding harmonic will be the last one used.
- Harmonic Zero – Exclude or Include (default Exclude)

For the distortion settings and harmonics setting, the values will be remembered whether the actual displaying of the reading is turned on or off. For example, if the number of harmonics to be displayed is changed from 7 to 13, turning off and then on again the display of voltage harmonics will not affect this setting.

The formula for voltage and current THD are:

$$Vthd = \frac{1}{V_{ref}} \sqrt{\sum_{min\ harm}^{max\ harm} (Vh_n)^2} \times 100\%$$

and

$$Athd = \frac{1}{A_{ref}} \sqrt{\sum_{min\ harm}^{max\ harm} (Ah_n)^2} \times 100\%$$

The Total Harmonic Distortion formula (previously called the series formula) will produce more accurate results for harmonic noise when the THD is less than 5%. When selecting the THD formula, it is important to set the MAX HARMONICS setting to an appropriately large number to get valid results. The higher the harmonic count the more accurate the calculation.

Telephone Influence Factor (TIF). TIF stands for telephone influence factor and is a THD measurement weighted at frequencies within the bandwidth of a normal telephone circuit. It is a measure of how the voltage or current distortion in electrical power circuits might interfere with adjacent telephone circuits. TIF measurements are a requirement of standards such as ANSI C50.13 "Rotating Electrical Machinery - Cylindrical-Rotor Synchronous Generators" and are most often used on standby power generators and UPS. The harmonics included in a TIF measurement are from 1 to 73 odd and even.

The formula for voltage and current TIF are:

Default reference = Fundamental

$$V_{tif} = \frac{1}{V_{ref}} \sqrt{\sum_{min\ harm}^{max\ harm} (k_n \times Ah_n)^2}$$

and

$$A_{tif} = \frac{1}{A_{ref}} \sqrt{\sum_{min\ harm}^{max\ harm} (k_n \times Ah_n)^2}$$

The weighting factors (K) are:

Harm	k ⁿ	Harm	k ⁿ	Harm	k _n
1	0.5	21	6050	41	10340
3	30	23	6370	43	10600
5	225	24	6650	47	10210
6	400	25	6680	49	9820
7	650	27	6970	50	9670
9	1320	29	7320	53	8740
11	2260	30	7570	55	8090
12	2760	31	7820	59	6730
13	3360	33	8830	61	6130
15	4350	35	8830	65	4400
17	5100	36	9080	67	3700
18	5400	37	9330	71	2750
19	5630	39	9840	73	2190

Minimum and maximum hold columns

For maximum and minimum hold menus, the columns can independently be enabled or disabled. To reset the values shown in the columns, press the [RESET] key. Also, each time either the minimum or maximum hold column is enabled, the values for both columns are reset.

SUM results column

SUM results will appear after the last channel in the group (and after that channels max and min results if necessary). Sum Max will appear to the right of the SUM results and Sum Min will appear to the left of the Sum results as appropriate.

SUM results are available in all wiring configurations except 1 phase, 2 wire (1P2W). (See page 44, *Wiring*.)

Modes

Default: Normal

Modes are used to set up the instrument in specific way to allow certain types of measurements. These specific modes provide all necessary filtering and unique configuration parameters necessary to measure specific signals found in certain applications.

Modes are applied on a group basis. For example, in light ballast applications, group A could be in normal mode measuring the input power and group B could be in ballast mode measuring the output power.

Currently there are three available modes. These are:

- Normal - This mode is used for most power measurements where signals are uniform and there are no special measurement methods required.
- Ballast - This mode is designed to configure the group to make measurements on the complex ballast output modulated waveforms.
- Standby Power- This mode integrates the Watts, Amps, VA and PF readings over a user-specified measurement period. This is a requirement of many standby power standards.

It is often necessary to force the instrument in to a certain way of operating when a particular mode is selected. An example is forcing high bandwidth when ballast mode is selected. In these cases two things will happen:

- a. Reverting back to normal mode will restore any changed settings
- b. When a setting is forced, it cannot be changed by the operator while the PA4000 is in the non-normal mode

Normal mode In normal mode, there are no special measurement methods used. Normal mode is suitable for most power applications and is the default mode.

Ballast mode In modern electronic lighting ballasts, it is often difficult to make accurate measurements due to the fact that the output signals are high frequency waveforms that are heavily modulated by the power frequency. Ballast mode provides a way of locking the measurement period to the power frequency.

After selecting ballast mode you need to set up the fundamental frequency at which power will be transmitted. This is typically 50, 60 or 400Hz. The setup screen can be found under the Modes → Setup Modes → Ballast Setup. The analyzer will then use this to adjust the measurement window to fit the specified frequency.

The frequency returned by the instrument is therefore not the fundamental power frequency, but instead the ballast switching frequency. This is also the frequency used for harmonic analysis.

When ballast mode is selected, the frequency range is set to “>10Hz” and the bandwidth is set to “High” for the group. These settings are locked out in ballast mode and, upon the return to normal mode, they are restored.

Standby power mode

Driven by consumer demand and energy efficiency legislation, there is an ever-increasing need to measure power consumption of product while they are in standby mode. One of the most widely used standards for measurement is IEC 62301. Part of this standard requires the measurement of power over a prolonged period of time without missing any short duration power events. The PA4000 standby power mode provides continuous sampling of voltage and current to produce an accurate Watts measurement over the user specified period.

In standby mode, you must specify the integration window in seconds. Watts, Amps, Power Factor and VA will then be integrated over the specified period. All other results will be updated at the normal user specified update rate.

The integration period is dependent on the combination of the specified window and the unit update rate. (See page 56, *Update rate*.) This is because the results will be integrated over an exact multiple of the update rate. For example, if the update rate is 0.5 seconds (default) then the integration period will always be exactly as specified. However, if an update rate of 0.4 seconds is requested, then integration period will switch between 1.2 seconds and 0.8 seconds.

For the most accurate measurements it is recommended that the ranges are fixed during the measurement period. (See page 47, *Fixed/Auto ranging*.)

Integrator mode

Integrator mode is used to provide measurements for determining energy consumption. In addition, for certain parameters, average values are also available.

The required measurements are selected in the *Measurements* menu. (See page 33, *Measurements*.) The integrator measurements are:

- Hours
- Watt-Hours
- VA-Hours
- VAr-Hours
- Amp-Hours
- Average Watts
- Average PF
- Corrected VAr
- Fundamental VA-Hours (VAHf)
- Fundamental VAr-Hours (VArHf)

These measurements are on a per-group basis. The measurements can only be selected and displayed when the group is in integrator mode. If an integrator measurement is selected and the mode is changed to a non-integrator mode, then the measurements will show as not being selected. Changing the group mode back to integrator mode will restore the selection previously used.

Configuring integrator mode. After selecting integrator mode, and the measurements to display, there are a number of options provided for starting and stopping the integrator. These are set up in the Modes -> Setup Mode -> Integrator Setup section of the menus.

Start method. Default: Manual

Manual starting: Manual starting of integration is triggered pressing the [INTEG RUN] key on the front panel. Pressing this key will start the integrator running on all groups that are configured as integrator mode with a manual start and are currently not running. The LED under the key will be turned on.

Clock Starting: In clock starting mode, you can set the time and date of when you want the integrator to start for the group. The time and date are entered in the user's specified format (see System configuration -> Clock menus). (See page 56, *Clock*.) Once the desired time has been reached, integration will start.

If, when the time / date combination in the clock start method is set, the time is before the current time and date, then integration will not start. Integration will only start when at least one screen update has occurred before the start time.

Level Starting: In this start method, you have the ability to start integrating when a certain parameter either goes above or below a user entered level. You can configure the following:

- Select the channel, 1 through 4
- Select the signal parameter from that channel. This can be any parameter with the exception of integrated values and harmonic values (including fundamentals)
- Select the level threshold to be monitored. This is the actual parameter value in decimal. For example for 80 mA enter 0.08, 80 V enter 80.
- Select whether the signal should be greater than or equal to the level or less than or equal to the level.
- A trigger channel 1-4 may be selected from any group and used as a trigger for integration. The trigger measurement does not have to be in the channel or group you are then integrating.

Once the conditions have been met, integration will start.

Stopping integration. The integration of a group can be stopped either manually or after a certain period of time. If the duration for the group is set to zero, then

the integration will only stop if the [INTEG. RUN] key is pressed. The duration is entered in minutes as a floating point number from 0.0 to 10,000.

Integration is manually stopped by pressing the [INTEG. RUN] key. This will stop integration on all groups that are in integrator mode with the integrator running where the duration is set to zero. The LED under the key will be turned off if there is no more integration going on within any group.

Resetting integration values. The [RESET/CLEAR] key will reset the integration values to zero for all stopped groups. It will not have any effect on groups that are running integration.

Correction VAR (CVAr). This parameter displays the values of VARs required to correct the average power factor to a target power factor. The target power factor is entered under the integrator setup screen under CVAr Power Factor.

The correction will calculate the necessary VARs to provide a phase shift to reach a target power factor. It does not compute the total VARs (e.g. if a poor power factor is completely due to distortion, no amount of phase lead or lag will improve it).

PWM Motor mode

PWM Motor mode has been designed to overcome the difficulties associated with making measurements on the complex waveforms found on the motor drive. High frequency sampling is combined with digital filtering to reject the carrier frequency and extract the motor frequency while still using pre-filtered data for power parameters.

After selecting PWM mode, you should then select the frequency range of the motor frequency (not the carrier frequency) under the Inputs -> Frequency Source -> Frequency Range menu.

When in PWM mode, the maximum motor frequency is limited to 900 Hz, even if a higher frequency range is selected.

The selection of the frequency range will impact the rate at which results are returned. The update rate for all the channels is set in the System Configuration menu. (See page 56, *Update rate*.) However, if the frequency range in PWM mode is set to either 1 – 100 Hz or 0.1 – 10 Hz, then the rate at which results are returned for that group is altered per the table below:

Update rate (seconds)	>10 Hz <900 Hz	1 – 100 Hz	0.1 Hz – 10 Hz
0.2	0.4	2.4	20.2
0.3	0.3	2.4	20.4
0.4	0.4	2.4	20.4
0.5	0.5	2.5	20.5
0.6	0.6	2.4	20.4
0.7	0.7	2.1	20.3
0.8	0.8	2.4	20.8

Update rate (seconds)	>10 Hz <900 Hz	1 – 100 Hz	0.1 Hz – 10 Hz
0.9	0.9	2.7	20.7
1.0	1.0	3.0	21.0
1.1	1.1	2.2	20.9
1.2	1.2	2.4	20.4
1.3	1.3	2.6	20.8
1.4	1.4	2.8	21.0
1.5	1.5	3.0	21.0
1.6	1.6	3.2	20.8
1.7	1.7	3.4	20.4
1.8	1.8	3.6	21.6
1.9	1.9	3.8	20.9
2.0	2.0	4.0	22.0

Results from channels not in PWM Motor mode will be returned at the specified rate.

Inputs

This menu may be used to set up the physical inputs of the PA4000. For normal operation, with the exception of the shunt selection, it is not necessary to change these settings from default.

Wiring

For multiphase measurements, a number of channels can be assigned to a group allowing precise frequency and phase analysis of the multiphase signals. The frequency of the first channel in the group is used as the fundamental frequency for all channels in the group, and all phase measurements are relative to the phase reference (Voltage by default) of the first channel in the group.

Below is a diagram showing how each channel would be connected for each different wiring mode.

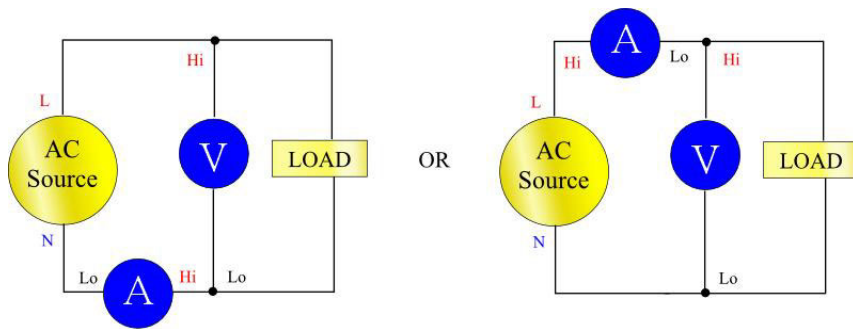

Single-phase, two-wire and DC measurements. Select 1 phase, 2 wire mode.

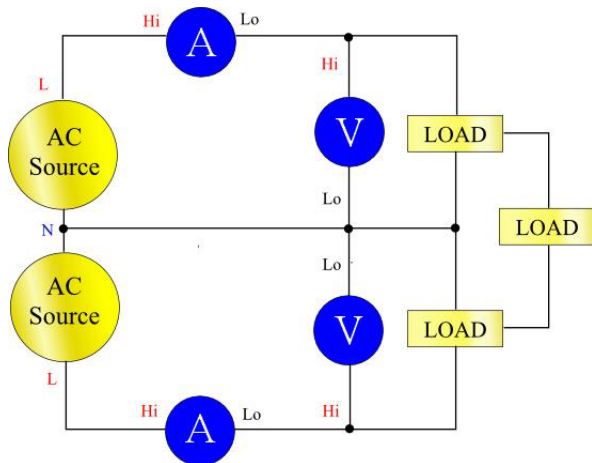

Single-phase, three-wire. Select 1 phase, 3 wire.

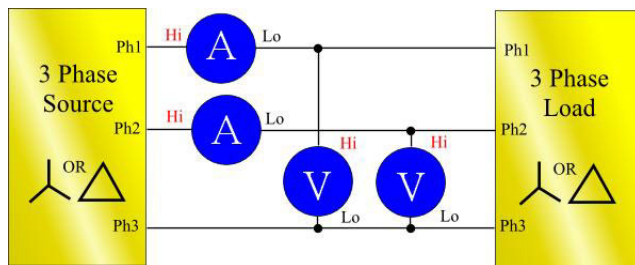

Three-phase, three-wire (2 Wattmeter method). Select 3 phase, 3 wire.

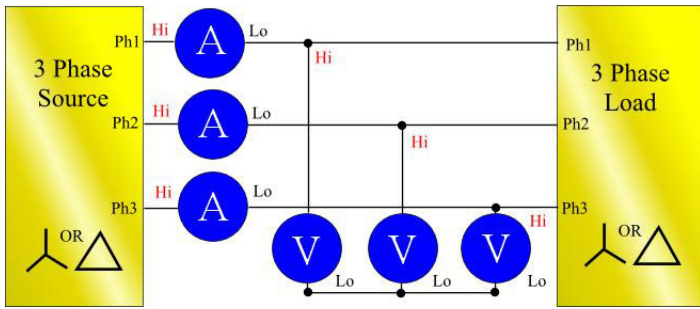

Three-phase, three-wire
(3 Wattmeter method). Select
3 phase, 4 wire.

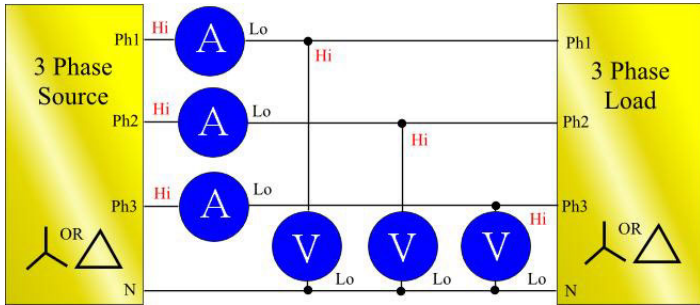

Three-phase, four-wire (3 Wattmeter
method). Select 3 phase, 4 wire.

Depending on the wiring configuration, not all groups will be available. For example, if wiring is 1p2w for each channel, then the 4 channels will correspond to the 4 groups. If the wiring is 1p3w for group A, then channels 1 and 2 will be in-group A. This will leave channels 2 and 3 for a maximum of groups B and C. Group D cannot exist in this condition.

Group A wiring takes priority, followed by groups B, C and then D. For example, starting from a 1p2w configuration for all groups, if group A is set to 1p3w, then group D can't be set to anything and therefore group C will be 1p2w only. Group B will have the choice of 1p2, 1p3w and 3p3w.

Ranges

The ranges are set on a group basis. The ranges will be as follows:

Range #	Volts	30 A shunt	1 A shunt	Ext. shunt
Auto				
3	2 V	0.2 A	0.005 A	0.003 V
4	5 V	0.5 A	0.0125 A	0.00375 V
5	10 V	1 A	0.025 A	0.015 V
6	20 V	2 A	0.05 A	0.03 V
7	50 V	5 A	0.125 A	0.0375 V
8	100 V	10 A	0.25 A	0.15 V
9	200 V	20 A	0.5 A	0.3 V
10	500 V	50 A	1.25 A	0.375 V
11	1000 V	100 A	2.5 A	1.5 V
12	2000 V	200 A	5 A	3 V

Fixed/Auto ranging Default: auto range

For most measurements, auto-ranging is the best choice. Choosing a fixed range may be useful if the voltage or current is changing continuously or has large peaks that make the analyzer spend excessive time changing range.

If you choose a fixed range, or the peak of the input signal is larger than the range, then an over range condition will occur. This will be indicated on the screen by all the results in the over ranged channel flashing on and off. In addition, the “Vrms” and/or “Arms” will flash to indicate whether the over-range is on either the voltage channel, the current channel, or both.

Shunts Default: 30A shunt

The PA4000 has 3 different current inputs, or shunts. They are:

- 30A shunt – Used for normal current measurement in the range of 100mA to 30Arms (200Apk). This selection uses the yellow Ahi and the black Alo 4mm sockets.
- 1A shunt – Used for small current measurements such as those found in standby power applications in the range of 2.5mA to 1A. This selection uses the blue A1A and the black Alo 4mm sockets.
- External shunt – Used for the measurement of current where an external transducer is used and the transducer has a voltage output. The blue and black 2mm sockets on each analog card are used for the external shunt inputs.



WARNING. *Passing an rms current of greater than 15 A through the 30 A shunt, with the selected shunt set to either 1 A or external, can cause damage to the 30 A shunt.*

See the Chapter ‘Using External Voltage and Current Transducers’ for further information.

Frequency source There are 3 selections under the Frequency Source menu. They are:

- Source
- Phase Reference
- Frequency Range

Source. Default: Voltage

Many measurements (including rms volts, amps and watts) are based on calculations that are dependent on the correct fundamental frequency being determined by the analyzer.

The PA4000 uses proprietary techniques to determine frequency that eliminate the problems created by noise when simple zero-crossing techniques are used.

It is therefore not normally necessary to adjust the settings from the default of voltage.

Volts. Volts is the default frequency source and is suitable for most applications.

Amps. Amps may be selected if the voltage waveform is heavily distorted, but the current is not. The waveforms at the output of a PWM motor drive are an example of this.

External Frequency 1 / 2. On the rear of the PA4000 there are 2 counter inputs on the Auxiliary Inputs / Outputs connector. Either of these can be used as an external frequency source for signals where there is too much noise on the voltage and current waveforms. Apply a TTL compatible square wave to the external input at the required frequency.

Phase Reference. Default:

Volts This is the zero reference for phase angle measurements in each group.

Volts. Phase is calculated with respect to the voltage signal on the first channel in the group.

Amps. Phase is calculated with respect to the current signal on the first channel in the group.

External Frequency 1 / 2. Phase is calculated with respect to the external input signal.

Frequency range. Default: 10 Hz - 50 kHz

There are 4 frequency ranges:

- 10 Hz - 50 kHz
- >10 Hz
- 1 - 100 Hz (PWM Motor mode only)
- 0.1 - 10 Hz (PWM Motor mode only)

For measurements where the fundamental is below 50 kHz, the range of “>10 Hz and <50 kHz” is recommended, especially at low signal levels.

If the fundamental frequency is greater than >50 kHz, then the range should be set to “>10 Hz”.

1 - 100 Hz and 0.1 - 10 Hz are used in PWM motor mode.

Bandwidth Default: High

The bandwidth is set on a per-group basis. Setting the bandwidth will apply a 10 kHz, two-pole filter to the voltage and current channel inputs.



WARNING. *If low bandwidth mode is selected, damage can be caused to the 30 A shunt if the current applied has a fundamental frequency of greater than 10 kHz and an rms value of greater than 20 A_{rms}.*

Scaling

Scaling is used to adjust the scaled output of transducers such as current transformers so that the true measured current is displayed on the PA4000. The scaling factor will affect every measured value related to the input to which it is applied.

Maximum scale factor: 100000

Minimum scale factor: 0.00001

Volts scaling. Default: 1.0000

Enter the scale factor of the transducer. For example, a 100:1 voltage transformer is used to measure 15 kV. The output of the transformer is 15000 / 100 = 150 V. Enter the scale factor 100, and the PA4000 will display 15,000 V.

Amps scaling. Default: 1.0000

Enter the scale factor of the transducer being used. For example, the Tektronix CL1200 produces 1 amp for every 1000 amps flowing in the opening of the CL. It is a 1000:1 current transformer. Enter the scale factor 1000 and the PA4000 will display the correct current.

Scale factor = Transducer Input Current / Transducer Output Current

External shunt scaling. Default: 1.000

This scaling is applied to the current measurement channel voltage inputs. This is used for current transducers that have a voltage output. These include Hall-effect transducers as well as simple resistive shunts.

The scaling factor is expressed in Amps (read) per Volt (applied).

The default value is 1. This means that with 1 V_{rms} applied, the current channel will read 1 A_{rms}.

An example would be a clamp-on Hall-effect current transducer measures up to 100 A. It has a voltage output of 10 mV per Amp, which is equivalent to 100 Amps per Volt. Enter '100.00' and the PA4000 will display the correct system current.

External phase compensation

Not yet implemented.

Analog inputs Default: ± 10 V range

The PA4000 has 4 analog inputs on the rear of the instrument. Each of the 4 inputs can be used to measure signal from a device such as a torque sensor. Each of the four inputs has 2 different ranges. The ranges are ± 10 V and ± 1 V. Each input is sampled every millisecond and the average value over the update rate of the instrument is displayed.

Analog inputs are made available to the MATH setup. They can be incorporated into the MATH formula and displayed on the MATH screen. (See page 52, *Math*.)

Graphs and waveforms

The PA4000 provides 4 graphical ways of displaying data:

- Waveforms
- Harmonic bar chart
- Vector diagram
- Integrator graphing

There are menu options for both waveforms and integrator graphing, bar charts and vector diagrams. (See page 11, *Quick view buttons*.)

Waveforms

The waveform menu allows you to select which waveforms to display on the waveform screen. For each group, you can select any voltage, current or Watts waveform for each channel in the group for displaying on the waveform graph. (See page 11, *Quick view buttons*.)

To change groups use the left and right arrow keys at the bottom left of the display.

Integrator parameters

The Integrator parameter menu allows you to select one parameter to display on the integrator graphing screen from the list of available integrator parameters below:

- Watt Hours
- VA Hours
- VAr Hours
- Amp Hours
- Watts Average
- PF Average
- Volts
- Amps

- Watts
- Fundamental VA-Hours (VAHf)
- Fundamental VAr-Hours (VArHf)
- Correction VAr

For each waveform selected, there is a choice on the graph menu to turn on or off the selected parameter for each channel in the group.

Integrator graphing parameters are set on a per-group basis. To change groups use the left and right arrow keys at the bottom left of the display.

For more information on setting up the integrator, (See page 41.). For more information on displaying the integrator waveforms, (See page 16.)

Interfaces

This menu may be used to set up the interfaces of the PA4000.

RS232 baud rate

Default: 38400

9600, 19200 and 38400 (default) are available.

The PA4000 uses hardware handshaking (RTS / CTS) with no parity, 8 data bits and 1 stop bit (N,8,1).

The RS232 baud rate is unchanged after a “*RST” or “:DVC” command.

GPIB Address

Default: 6

Enter the GPIB address.

Default address is 6. The address is unchanged after a “*RST” or “:DVC” command.

Printing

Not yet implemented.

Ethernet Configure

The PA4000 offers Ethernet communications through an Ethernet port using TCP/IP.

The Ethernet port will make a TCP/IP connection on port 5025. Port 5025 is designated by the Internet Assigned Numbers Authority (IANA) to be a SCPI port.

Use the IP Selection Method menu, to opt for a dynamically assigned IP address, by selecting “Set IP using DHCP”, or a fixed/static IP address by selecting “Fix IP Address”.

To view the current IP settings, press the [SETUP] key.

To configure the static IP address, choose “Static IP Settings” in the Ethernet Setup menu. This allows entry of the IP address, the subnet mask and the default gateway. After entering the relevant data press the OK button, in each menu, to apply.

For basic communication needs via TCP/IP the user can try the Agilent Connection Expert contained in the Agilent IO Libraries Suite 15.0.

The Ethernet mode (Static/DHCP), IP address, default gateway and subnet mask are unchanged after a “*RST” or “:DVC” command.

Datalog

Future implementation.

Math

The math results are displayed on a different results screen from the other results. This improves the ability to view math results. Normal measurement parameters can be displayed on the math results screen. They just have to be specified in a formula. (See page 18, *Math screen.*)

The user is able to set the values of up to 30 math functions, labelled FN1 through FN30. For each function you can specify the following:

- Name – User-friendly name up to 10 characters. (Default is the same as the label i.e. FN1). In the menus, the function label is always displayed alongside the users name for the function.
- Units – User friendly units such as W for Watts. (Default is blank). Scaling such as u, m, k, M will be added to the unit as appropriate. Units are up to 4 characters.
- Equation – The actual math formula, up to 100 characters.

Example: $W = 21.49$, $VA = 46.45$

Name = “PF”

Units = “PF”

Equation = “CH1:W / CH1:VA” $W = 21.49$ and $VA = 46.45$

To select this equation for viewing go to the MATH menu list showing FN1 – FN30 and apply the green tick to the one you wish to view. Next press the [MATH] hard key to display your equation, the math’s results display will show “PF 463.27 mPF”

Example: $CH1:W = 21.49$, $CH2:W = 53.79$

Name = “EFFICIENCY”



Units = “W”

Equation = “CH1:W / CH2:W”

To select this equation for viewing go to the MATH menu list showing FN1 – FN30 and apply the green tick to the one you wish to view. Next press the [MATH] hard key to display your equation, the math’s results display will show “EFFICIENCY 399.95 mW “

You can specify any channel or group parameter listed below in addition to the voltage input on each of the 4 analog inputs.

- Valid character are A-Z, 0-9,.,, x, -, +, /, (,), :, space, and ^
- No more than 255 characters can be used
- The number format is [+/-] <decimal digits>[E[+/-]exponent]

When entering a formula you can use the left and right arrow keys ( ) to move the cursor. This allows for easy correction and changing of complex formulae.

Each math function can be either enabled or disabled. Only enabled results are available for display.

The valid channel parameters are CH<1-4> followed by ":" and then one of the following parameters:

VRMS	Volts RMS	ARMS	Amps RMS
W	Watts	FREQ	Frequency
VA	Volt-Amps	VAR	Volt-Amps Reactive
VDC	Volts DC	ADC	Amps DC
VRMN	Rectified Mean Volts	ARMN	Rectified Mean Amps
PF	Power Factor	VPKP	Volts Peak (positive)
VPKN	Volts Peak (negative)	APKP	Amps Peak (positive)
APKN	Amps Peak (negative)	VCF	Volts Crest Factor
ACF	Amps Crest Factor	Z	Impedance
WF	Fundamental Watts	VARF	Fundamental Volt-Amps Reactive
VF	Fundamental Volts	AF	Fundamental Amps
PFF	Fundamental Power Factor	R	Resistance
X	Reactance	VDF	Voltage Distortion Factor
VTHD	Voltage Total Harmonic Distortion	VTIF	Voltage Telephone Influence Factor

ADF	Current Distortion Factor	ATHD	Current Total Harmonic Distortion
ATIF	Current Telephone Influence Factor	VHM<1-99>	Voltage Harmonic Magnitude (1-99)
VHA<1-99>	Voltage Harmonic Angle (1-99)	AHM<1-99>	Current Harmonic Magnitude (1-99)
AHA<1-99>	Current Harmonic Angle (1-99)	WHM<1-99>	Watts Harmonic Magnitude (1-99)
VRNG	Voltage Range	ARNG	Current Range
AHR	Ampere Hours	WHR	Watt Hours
VAHR	VA Hours	VARH	Watt Hours
WAV	Watts Average	PFAV	PF average
CORRVARs	Correction VARs	TINT	Integration Time (Hours)

The valid group parameters are GRP<A-D > followed by ":SUM:" and then one of the following parameters:

VRMS	Volts RMS	ARMS	Amps RMS
W	Watts	VA	Volt-Amps
VAR	Volt-Amps Reactive	PF	Power Factor
AHR	Ampere Hours	WHR	Watt Hours
VAHR	VA Hours	VARH	VAr Hours
WAV	Watts Average	PFAV	PF average
TINT	Integration Time	CORRVARs	Correction VARs
WF	Fundamental Watts	VF	Fundamental Volts
AF	Fundamental Amps	VARF	Fundamental Volt-Amps Reactive
PFF	Fundamental Power Factor		

The follow parameters are used to return the values from the analog inputs:

ANA1	Analog Input 1	ANA2	Analog Input 2
ANA3	Analog Input 3	ANA4	Analog Input 4

In addition, a function can refer to another function by using “FNx” where x is the function number. Functions will be calculated in the order of 1 through 30, so this will have to be factored in when writing equations.

Operators available from the front panel keyboard are:

- + - x / ()
- X² - {shown as ^2 and will square the preceding number}

- X^y - {shown as ^ and will take the preceding number to the power of the following number}
- $\sqrt{\quad}$ - {shown as SQRT() and will take the square root of the number between the brackets}

Operators that may be typed:

- SIN(), COS(), TAN() {which take an angle in degrees which is between the brackets and return its sine, cosine or tangent}
- ASIN(), ACOS() {which take a number between -1 and 1 which is between the brackets and return an angle in degrees}
- ATAN() {which takes a number that is between the brackets and return an angle in degrees}
- LN(), LOG() {which returns the logarithm of the number between the brackets. LN is log to the base e, LOG is log to the base 10}

Constants that may be typed:

- PI() (3.14159)

Tip:. When the blue shift key LED is illuminated operators such as COS(), SIN() and TAN() will be entered as whole words whereas ACOS(), ASIN(), ATAN(), LN() and LOG() must be typed as individual letters when the blue shift key L.E.D is illuminated.

The formula is checked for validity when OK is selected. If there is an error, then an error message is displayed. If there are no errors then a dialog box will be displayed showing the calculated value.

To leave the formula entry screen press the back arrow button (◀).

If the math result is invalid (for example, infinity because of a divide by zero) the display will show 4 dashes.



System configuration

Blanking Default: Enabled

Normally enabled, select Disable to measure voltage or current that is small.

The blanking levels are set to 5% of the currently selected range, with the exception of the lowest current range. For the lowest current range, blanking is set to 10%.

If blanking operates on either voltage or current then all related measurements would be blanked including W, VA and PF.

- Update rate** Default: 0.5
- The update determines the period over which samples are accumulated and updated.
- The range is 0.2 second to 2 seconds in 0.1 second increments. With update rates below 0.5 seconds, the number of results that can be updated at that rate is limited.
- Averaging** Default: 10
- An averaging depth of between 1 and 10 can be specified. The default value is 10. With the update rate set to 0.5 seconds (the default), this corresponds to values being averaged over 5 seconds.
- If the range is changed, then the averaging is reset.
- Auto Zero** Default: On
- Normally the PA4000 will cancel any small dc offsets in the measurement automatically. This is called Auto Zero.
- Auto Zero should normally be enabled. If it is disabled, then the values obtained from the last auto zero run will be used.
- Selecting Run Now and pressing  will run the auto zero immediately. This takes approximately 100 ms. The state of whether auto zero is either enabled or disabled will not be changed, and there is no feedback to indicate it has run. The auto zero will only be run on the currently selected ranges.
- Host / Client** Future implementation.
- Clock** These options may be used to check or set the PA4000's internal clock:
- Set Time - Enter the time using the format shown and press OK to confirm.
 - Set Date - Enter the date using the format shown and press OK to confirm.
 - Time Format - Select 12 Hour or 24 Hour and press  to confirm.
 - Date Format - Select the required date format and press  to confirm.
- Power saving** The PA4000 has the ability to reduce its own power consumption by switching off the display.
- Display.** Default: Always on

In the display menu you have 3 options:

- Always On – This is the default mode and the display will always be on.
- Switch off after 10 minutes – With this selection, the display will switch off after 10 minutes if no key is pressed. Pressing any key will bring the display back on. The key press will perform no other action.
- Switch off in remote mode – With this selection, if the PA4000 receives a command via any of the communication interfaces, the display will go off. Pressing any key will turn the display back on, but the PA4000 will remain in remote mode until the [LOCAL] key is pressed. Pressing the [LOCAL] key to switch the display on will not return the PA4000 to local mode.

Analyzer configuration

The analyzer configuration menu has the same function as the [SETUP] key. Selecting this will display the complete setup of the instrument. You can use the up and down soft keys to scroll through the configuration.

Pressing the right arrow key will change the configuration screen to display information on the physical unit. This includes the serial number of the unit, the firmware version and information on the main card and analog cards, including calibration date.

Optional functionality

Future implementation.

User configuration

The PA4000 has the ability to store and recall up to 8 user configurations and also to recall a default configuration.

The first option is to ‘Load Default Configuration’. Choosing this option by pressing sets every menu option of the PA4000 to its factory default. The defaults are listed in previous sections of this chapter.

For each User Configuration you can go in to sub menu and you may:

- Apply – apply the saved configuration.
- Rename – give the configuration a meaningful name. A name can be up to 16 characters.
- Save Current Configuration– save a configuration. This is always the complete setting of the PA4000 at the time you choose this option.
- Print – Not yet implemented.

- Save to USB – Not yet implemented.
- Load from USB – Not yet implemented.

NOTE. *Loading a configuration that has never been saved will result in an error message. The current configuration of the unit will not be changed.*

Remote operation

Overview

Using the remote commands the PA4000 can be used to perform high speed, complex or repetitive measurements. All PA4000s have the ability to communicate via RS232, Ethernet, or via USB as standard. Optionally, a GPIB port can be added.

Interfacing with RS232 systems

The RS232 port is a standard PC type 9-way male D-type located on the rear of the instrument and may be used for remote control of the PM6000. A modem cable should be used.

The RS232 port uses 8 bits, no parity, one stop bit and hardware flow control.

See *Serial Port* for a detailed pin description of the RS232 connector. (See page 98, *Serial port*.)

See *RS232 Baud Rate* for details on the interface menus.(See page 51, *RS232 baud rate*.)

Interfacing with USB systems

The PA4000 supports USB control using the Test and Measurement class.

A detailed pin description of the port, along with speed and connection information is given in the specifications. (See page 99, *USB peripheral*.)

Interfacing with Ethernet systems

The PA4000 supports Ethernet control using a 10Base-T network.

See *Ethernet Port* for more information on the Ethernet connection. (See page 100, *Ethernet port*.)

See *Ethernet Configure* for information on how to set up the Ethernet addressing information.(See page 51, *Ethernet Configure*.)

Interfacing with GPIB systems (optional)

The PA4000 optionally supports control via a GPIB port. This option must be installed by an authorized Tektronix representative.

See *IEEE 488/GPIB* for a detailed pin description of the GPIB connector. (See page 98, *IEEE 488 / GPIB (optional)*.)

Status reporting

Status byte

The PA4000 uses a similar status byte to IEEE488.2. The PA4000 Status Byte Register (STB) contains the ESB and DAS bits. These two bits indicate a non-zero state in the Standard Event Status Register (ESR) or the Display Data Status Register (DSR) respectively.

The ESR and DSR each have enable registers, ESE and DSE respectively, that is set by the user. These enable registers act as a mask to reflect chosen elements of the appropriate status registers to the Status Byte Register. Setting the appropriate bit of the enable register to 1 configures transparency.

If a status register is read, that register is reset to zero.

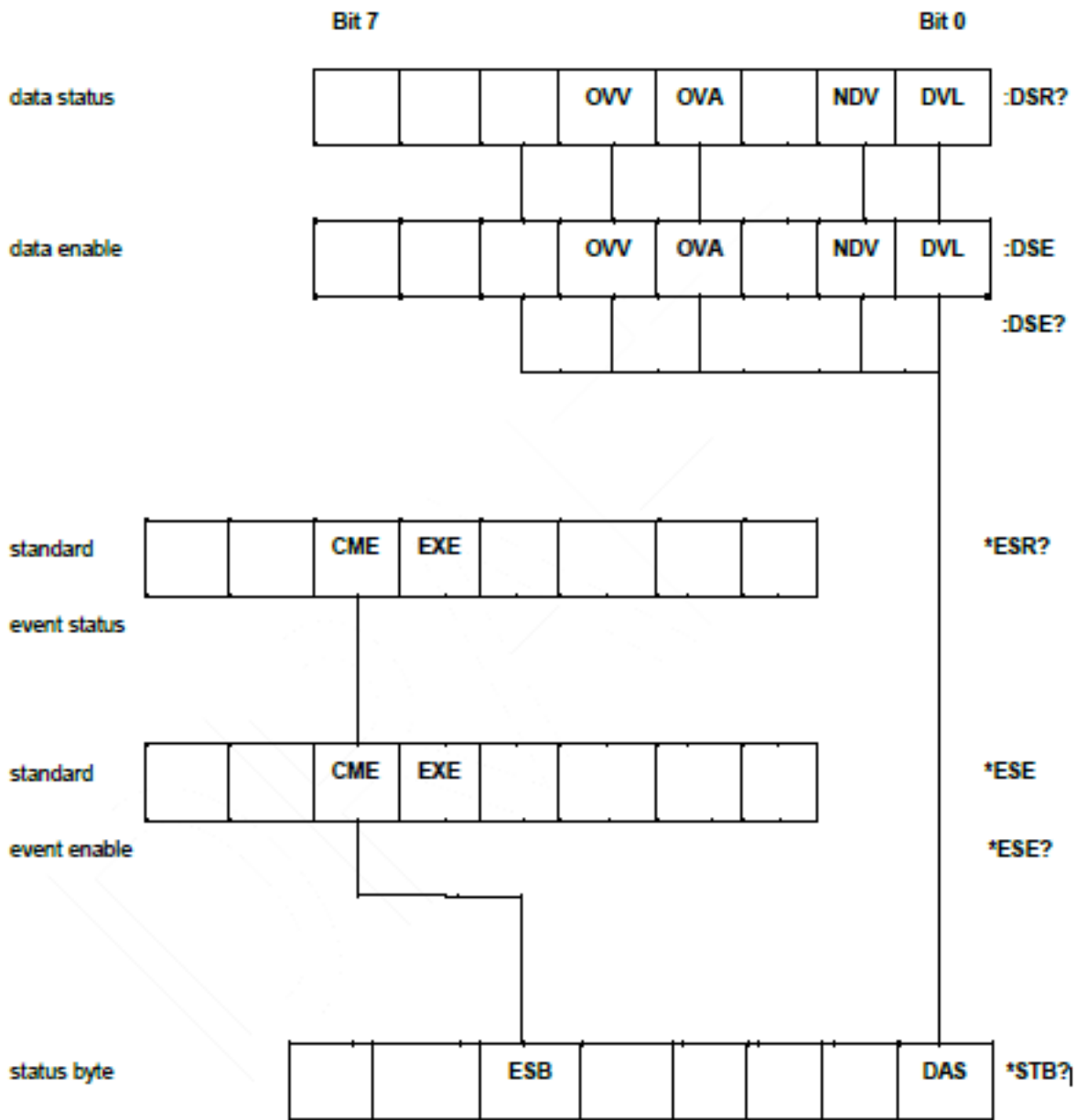

Status Byte Register (STB) Read by “*STB?”.



Bit 5 - ESB Summary bit to show standard event status.

Bit 0 - DAS Summary bit to show display data available.

Display Data Status Register (DSR)

Read by “:DSR?” or in summary by *STB? DAS bit. On power-up DSR is initialized to zero. When read using the “:DSR?” command the register bits are cleared as listed below.

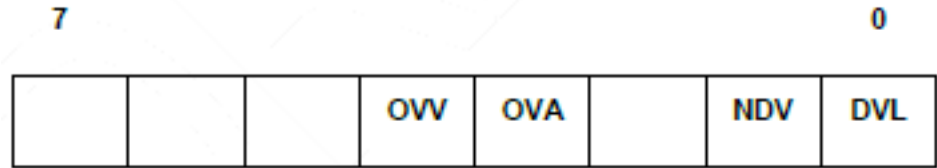

Bit 4 - OVV. Set to indicate there is a voltage range overload. Automatically cleared when range overload clears.

Bit 3 - OVA. Set to indicate there is a current range overload. Automatically cleared when range overload clears.

Bit 1 - NDV. Set to indicate that new data has become available since the last :DSR? command. Cleared when read.

Bit 0 - DVL. Set to indicate the availability of data. Cleared when read.

Display Data Status Enable Register (DSE)

Read by “:DSE?” and set by “:DSE <value>”.

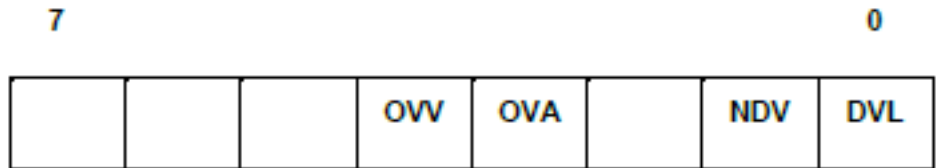

Bit 4 - OVV. Enable OVV bit in DSR.

Bit 3 - OVA. Enable OVA bit in DSR.

Bit 1 - NDV. Enable NDV bit in DSR. (Default to enabled on power-up.)

Bit 0 - DVL. Enable DVL bit in DSR. (Default to enabled on power-up.)

Standard Event Status Register (ESR)

Read by “*ESR?” or in summary by the ESB bit in STB.

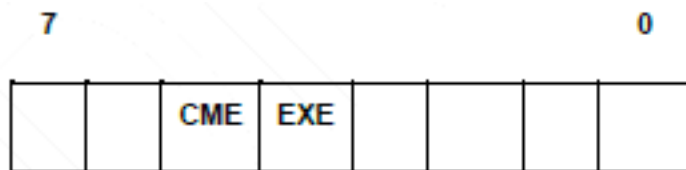

Bit 5 - CME. Command error; command not recognized.

Bit 4 - EXE. Command execution error.

Standard Event Status Enable Register (ESE)

Read by “*ESE?” and set by “*ESE <value>”. Cleared when read.

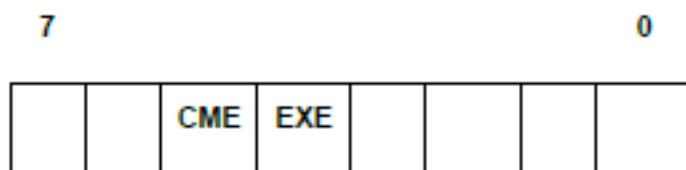

Bit 5 - CME. Enable CME bit in ESR. (Default to enabled on power-up.)

Bit 4 - EXE. Enable EXE bit in ESR. (Default to enabled on power-up.)

Command listing

The following conventions are used for command syntax:

- Square brackets indicate optional parameters or keywords []
- Triangle brackets indicate values to be specified < >
- Vertical bar indicates the choice of parameters |

Commands and responses are sent as ASCII strings terminated with a line feed. The PA4000 is not case sensitive and white space characters are ignored except where required between command and parameter.

Multiple commands cannot be sent in a single string where a ‘;’ character is used at the end of each command.

For all commands where a parameter is supplied, a space is required between the end of the command and the first parameter i.e. “:SYST:CTYPE? 1” will work. “:SYST:CTYPE?1” will cause a time out error.

The list of commands is split into relevant sections. In general each section corresponds to a menu option from the main menu on the PA4000.

IEEE 488.2 standard commands and status commands

*IDN?	Unit identity
Syntax	*IDN?
Return format	Tektronix, PA4000, serial number, Firmware version
Description	The serial number is the serial number of the main chassis. The firmware version is the version of the firmware suite, which includes all processors
*CLS	Clear event status
Syntax	*CLS
Return format	None
Description	Clears the standard event status register to 0
*ESE	Set standard event status enable register
Syntax	*ESE <flags> Where flags = value for enable register as a decimal 0 – 255
Default	48
Description	Sets the bits that are enabled in the standard event status register. The status enable register uses the same bit definitions as the standard event status register
*ESE?	Read standard event status enable register
Syntax	*ESE?
Return format	0 - 255
Description	Returns the value in the standard event status enable register.
*ESR?	Read event status register
Syntax	*ESR?
Return format	0 - 255
Description	Returns the value in the standard event status register, AND'ed with the value in the standard event status enable register. The event status register is cleared once it has been read

***RST Reset device**

Syntax	*RST
Return format	None
Description	Resets the unit configuration to default values (performs the same action as Load Default Configuration menu option on the front panel)

Tip. Allow 5 – 10 seconds after *RST has been sent prior to executing further commands to allow all defaults to be processed and set.

***STB? Read status byte**

Syntax	*STB?
Return format	0 - 255
Description	Returns the value in the status byte, masked by the service request enable register. Once read, the status byte is cleared to 0

:DSE Set Data Status Enable Register

Syntax	:DSE <flags>
Default	255
Description	Sets the bits that are enabled in the display status register

:DSE? Read Data Status Enable Register

Syntax	:DSE?
Return format	0 – 255
Description	Returns the value in the data status enable register

:DSR? Read Data Status Register

Syntax	:DSR?
Return format	0 – 255
Description	Returns the value in the data status register, AND'ed with the value in the data status enable register. The data status register is cleared once it has been read

:DVC Device clear

Syntax	:DVC
Return format	None
Description	Performs a soft reboot. This has the same effect as *RST or :CFG:USER:LOAD 0 (loading the default user configuration)

Channel and group commands

The following commands are used to select the active group or channel. They are similar in concept to pressing the left and right arrow keys to change the group or channel while displaying a menu screen.

:INST:NSEL Set active group

Syntax	:INST:NSEL <group number> <group number> is an integer between 1 and 4, depending on the number of groups available in the PA4000
Return format	None
Description	Sets the specified group as the active group for command and actions that may follow

:INST:NSEL? Read active group

Syntax	:INST:NSEL?
Return format	<group number>
Description	Returns the number of the group selected (between 1 and 4 depending on wiring configuration)

:INST:NSELC Select active channel

Syntax	:INST:NSELC <channel number> <channel number> is an integer between 1 and 4, depending on the number of channels installed in the PA4000
Return format	None
Description	Sets the number of the channel selected (between 1 and 4 depending on number of channels installed in the PA4000)

:INST:NSELC? Return active channel

Syntax	:INST:NSELC?
Return format	<channel number>
Description	Returns the number of the channel selected (between 1 and 4 depending on number of channels installed)

Unit information commands

The Unit Information commands are commands that are used to return information on the unit beyond the information returned by the *IDN? command.

:CAL:DATE? Calibration date

Syntax	:CAL:DATE? <channel number, <date type> Where <channel number> is 1 through 4. <date type> is 1 through 2
Return format	Appropriate calibration date in the format dd-mm-yyyy
Description	Returns the calibration date from the designated analog card. <date type> can be either: 1 = Date verified 2 = Date adjusted

:SYST:CTYPE? Card type

Syntax	:SYST:CTYPE? <channel number> Where <channel number> is 0 through 4 <serial number> is a 12 character string <hardware revision> is up to 4 characters
Return format	Tektronix, <card type>, <serial number>, <hardware revision> <card type> is either CPU for the main card, or ANALOG for a channel card <serial number> is a 12 character string <hardware revision> is up to 4 characters
Description	Returns the card type, serial number and hardware revision for the designated channel. Channel 0 is the main CPU card

Measurement selection and reading commands

These commands are related to selecting the measurements required and returning those results.

:SEL Select results

Syntax :SEL:CLR
 :SEL:CLR:GRP<group>
 :SEL:<measurement>

Where <group> is a group number 1 through 4.

Where <measurement> is:

VLT - Volts rms
 AMP - Amps rms
 WAT - Watts
 VAS - VA
 VAR - VAr
 FRQ - Frequency
 PWF - Power factor
 VPK+ - Volts peak (positive)
 VPK- - Volts peak (negative)
 APK+ - Amps peak (positive)
 APK- - Amps peak (negative)
 VDC - Volts DC
 ADC - Volts DC
 VRMN - Volts rectified mean
 ARMN - Amps rectified mean
 VCF - Voltage crest factor
 ACF - Amps crest factor
 VTHD - Volts Total Harmonic Distortion
 VDF - Volts Distortion Factor
 VTIF - Volts Telephone Influence Factor
 ATHD - Amps Total Harmonic Distortion
 ADF - Amps Distortion Factor
 ATIF - Amps Telephone Influence Factor
 IMP - Impedance
 RES - Resistance
 REA - Reactance
 HR - Integrator time *1
 WHR - Watt Hours *1
 VAH - VA Hours *1
 VRH - VAr Hours *1
 AHR - Amp Hours *1
 WAV - Average Watts *1
 PFAV - Average Power Factor *1
 CVAR - Correction
 VArS *1 VF - Fundamental Volts rms
 AF - Fundamental Amps rms

Select results (cont.)

WF - Fundamental Watts
VAF - Fundamental VA
VARF - Fundamental VAR
PFF - Fundamental Power Factor
VHM - Volts harmonics
AHM - Amps harmonics
WHM - Watts harmonics
*1 – These results are only available
for displaying / returning when the
group is in integrator mode.

Description :SEL determines which results
are displayed on the screen also
the results returned by the FRD?
command. To see the currently
selected command the "FRF?"
command should be used.
SEL:CLR clears all the results
selected for all groups. Adding the
secondary command of :GRP" allows
only those results within the specified
group to be cleared.
To add results to a group the
command ".INST:NSEL <group> must
be used first. If it is not, then the last
selected group will be affected (or
group 1 if no group has previously
been selected).

:FRF? Read selected results

Syntax :FRF?

:FRF:GRP<group>?

:FRF:CH<channel>?

Where <group> is a group number 1 through 4

Where <channel> is a channel number 1 through 4

Description

FRF? and FRF:GRP? commands are used to return a list of the displayed results. The actual result is not returned. The return format is:

<group>, <number of measurements selected>, <number of results returned>, <measurement 1>,<measurement 2>,... and so forth, <group>,<number of measurements selected>,...

<number of measurements selected> is the number of measurements selected using either the front panel or the SEL command

<number of results returned> equates to the number of rows on the display used. When harmonics are selected, the number of results returned will exceed the number of measurements selected

<measurement 1> and so forth, is the name of the measurement selected.

The returned data will be the same as the label used on the results display. For harmonics "Vharm", "Aharm and "Wharm" will be returned

Each value will be returned separated by a comma

FRF? will return the selections for all groups

:FRF:CH<channel>? will return the list of results for a particular channel.

This is useful for ease of measurements. The data returned for this command will be the same as "FRF:GRP?", except the channel number will also be included. For example:

<group>, <channel>, <number of measurements selected>, <number of results returned>, <measurement 1>,<measurement 2>,... and so forth, <group>,<channel>, <number of measurements selected>,...

:MOVE Move results

Syntax :MOVE:<measurement> <new position>

<measurement> is the list of measurements defined in :SEL.

<new position> is the position in the list of results on the screen and is in the range 1 through 43.

Description

The move command is used to change the order of results on both the screen in the returned results using FRD?. FRF? can be used to confirm the order of results.

:FRD? Read foreground data

Syntax	<p>:FRD? :FRD:CH<ch>? :FRD:GRP<group>? Where <ch> is a channel number 1 through 4 Where <group> is a group number 1 through 4</p>
Description	<p>The FRD commands returns results from the analyzer. The results are returned in the order in which they are displayed on the screen. Each result is a floating point number separated by a comma</p> <p>The sequence is determined by order in which results are displayed on the front panel. The sequence can be configured either by the user changing the order using the front panel of the instrument, or by using the :MOVE command</p> <p>Results will be returned column by column starting from the left of the display. This means that if the user has selected SUM results or maximum and minimum results to be displayed, then these results will also be returned</p> <p>For :FRD:CH<ch>?, if minimum or maximum results are selected, these will be returned. The order will be <min>, <ch>, <max></p> <p>For :FRD:GRP<group>?, if minimum, maximum or SUM results are selected, these will be returned. The order will be <min>, <ch>, <max>, <min>, <ch>, <max>,....<sum min>, <sum>, <sum max></p> <p>For :FRD?, each group will be returned starting with group A. The order of the results with the group will be the same as the :FRD:GRP<group>? command</p>

Measurement configuration commands

Measurement configuration commands correspond to the Measurement Configuration Menu. (See page 37, *Measurements configuration*.)

:HMX:VLT/AMP Commands for configuring the display of harmonics.

Harmonics configuration

Syntax	<p>:HMX:VLT:SEQ <value> :HMX:AMP:SEQ <value> Where <value> equals 0 for odd and even and 1 for odd only.</p>
Description	<p>If harmonics measurements are selected (see :SEL), the PA4000 can display all harmonics, or just the odd number harmonics from the first harmonic up to the number specified.</p> <p>This command works on a group. Use the :INST:NSEL command first to select the active group.</p>

Harmonics configuration (cont.)

Syntax :HMX:VLT:RNG <value>
 :HMX:AMP:RNG <value>
 Where <value> = the maximum harmonic to be display in the range of 1 to 100.

Description If harmonics measurements are selected (see :SEL), the PA4000 will display all the harmonics up to the number specified by <value >. The harmonics displayed can be restricted to odd numbered harmonics only using the harmonic sequence command.
 This command works on a group. Use the :INST:NSEL command first to select the active group.

Syntax :HMX:VLT:FOR <value>
 :HMX:AMP:FOR <value>
 Where <value>
 = 0 absolute values
 = 1 percentage values

Description If harmonics measurements are selected (see :SEL), the PA4000 can display all harmonics (except the first) as an absolute value or as a percentage of the fundamental (first) harmonic.
 This command works on a group. Use the :INST:NSEL command first to select the active group.

:HMX:VLT/AMP:DF Commands for setting up the distortion factor measurements.

Distortion factor setup

Syntax :HMX:VLT:DF:REF <value>
 :HMX:AMP:DF:REF <value>
 Where <value> = 0 fundamental
 = 1 rms

Description For distortion factor readings (also known as the difference formula), the reference on the denominator of the equation can be either the rms reading or the fundamental harmonic reading.
 This command works on a group. Use the :INST:NSEL command first to select the active group.

:HMX:VLT/AMP:THD Commands for setting up the total harmonic distortion measurements.

Total harmonic distortion setup

Syntax	:HMX:VLT:THD:REF <value> :HMX:AMP:THD:REF <value> Where <value> = 0 fundamental = 1 rms
Description	For total harmonic distortion (THD) readings (also known as the series formula), the reference on the denominator of the equation can be either the rms reading or the fundamental harmonic reading. This command works on a group. Use the :INST:NSEL command first to select the active group.
Syntax	:HMX:VLT:THD:SEQ <value> :HMX:AMP:THD:SEQ <value> Where <value> = 0 for odd and even = 1 for odd only
Description	For total harmonic distortion (THD) readings (also known as the series formula), the harmonics used in the measurement can include all harmonics up to the specified number or only the odd harmonics. This command works on a group. Use the :INST:NSEL command first to select the active group.
Syntax	:HMX:VLT:THD:RNG <value> :HMX:AMP:THD:RNG <value> Where <value> = the maximum harmonic to be display in the range of 2 to 100.
Description	For total harmonic distortion (THD) readings (also known as the series formula), <value > is used to specify the maximum harmonic number used in the formula. This command works on a group. Use the :INST:NSEL command first to select the active group.
Syntax	:HMX:VLT:THD:NZ <value> :HMX:AMP:THD:NZ <value> Where <value> = 0 for exclude = 1 for include
Description	For total harmonic distortion (THD) readings (also known as the series formula), the formula can either include or exclude the DC component. This command works on a group. Use the :INST:NSEL command first to select the active group.

:HMX:VLT/AMP:TIF Telephone influence factor set-up

Syntax :HMX:VLT:TIF:REF <value>
 :HMX:AMP:TIF:REF <value>
 Where <value> = 0 fundamental
 = 1 rms

Description For telephone influence factor readings, the reference on the denominator of the equation can be either the rms reading or the fundamental harmonic reading.
 This command works on a group. Use the :INST:NSEL command first to select the active group.

:MIN Minimum column

Syntax :MIN <value>
 Where <value> = 0 for disabled
 = 1 for enabled

Description The MIN command adds a column to the results that displays the minimum value of each parameter since the last time the minimum values were reset. A column is added for each channel in the group, as well as for SUM results if they are selected.
 Enabling the column will always reset the MIN and MAX values for the currently selected group. The values can also be reset by using the :RES command or pressing the [RESET/CLEAR] button on the front panel.
 To reset the MIN hold values, send the command :MIN 1 to re-enable the column. Note that both MIN and MAX hold values will be reset.
 This command works on a group. Use the :INST:NSEL command first to select the active group.

Syntax :MIN?

Return 0 or 1

Description Returns the status of the minimum value column. A 0 will be returned if disabled; a 1 if enabled.
 This command works on a group. Use the :INST:NSEL command first to select the active group.

:MAX Maximum column

Syntax	:MAX <value> Where <value> = 0 for disabled = 1 for enabled
Description	The MAX command adds a column to the results that displays the maximum value of each parameter since the last time the maximum values were reset. A column is added for each channel in the group, as well as for SUM results if they are selected. Enabling the column will always reset the MIN and MAX values for the currently selected group. The values can also be reset by using the :RES command or pressing the [RESET/CLEAR] button on the front panel. To reset the MAX hold values, send the command :MAX 1 to re-enable the column. Note that both MIN and MAX hold values will be reset. This command works on a group. Use the :INST:NSEL command first to select the active group.
Syntax	:MAX?
Return	0 or 1
Description	Returns the status of the maximum value column. A 0 will be returned if disabled; a 1 if enabled. This command works on a group. Use the :INST:NSEL command first to select the active group.

:SUM SUM results

Syntax	:SUM <value> Where <value> = 0 for disabled = 1 for enabled
Description	The SUM command adds a column to the results that displays the SUM values of each parameter selected (where applicable) for a group. This command works on a group. Use the :INST:NSEL command first to select the active group. If the currently selected groups wiring mode is 1 phase, 2 wire, then a request to add SUM results will be ignored.
Syntax	:SUM?
Return	0 or 1
Description	Returns the status of the SUM results column. A 0 will be returned if disabled; a 1 if enabled. This command works on a group. Use the :INST:NSEL command first to select the active group.

Mode setup commands

The mode set up commands correspond to the Modes menu. (See page 40, *Modes*.) They are used to control how groups are configured to measure parameters in certain conditions.

:MOD Mode

Syntax :MOD:NOR (normal mode)
 :MOD:BALL (ballast mode)
 :MOD:SBY (standby power mode)
 :MOD:INT (integrator mode)
 :MOD:PWM (PWM Motor mode)

Description This command will set the mode for the group. Since this command works with a group, use the :INST:NSEL command first to select the active group.

Syntax :MOD?

Return format Mode number from 0 to 4.

Description This command will return a reference to mode for the active group. Since this command works with a group, use the :INST:NSEL command first to select the active group.

The returned values are:

0 – Normal Mode

1 – Ballast Mode

2 – Standby Power Mode

3 – Integrator Mode

4 – PWM Motor Mode

:MOD:BALL Ballast mode

Syntax :MOD:BALL:FREQ <value>
 Where <value> is the power frequency in the range of 45 to 1000Hz.

Description This command will set the power frequency for ballast mode. (See page 40, *Ballast mode*.) Since this command works with a group, use the :INST:NSEL command first to select the active group.

Syntax :MOD:BALL:FREQ?

Return format Ballast frequency for the selected group.

Description This command returns the ballast frequency for the active group. Since this command works with a group, use the :INST:NSEL command first to select the active group.

:MOD:SBY Standby mode

Syntax	:MOD:SBY:PER <value> Where <value> is the standby power integration period in the range of 1 to 1200 seconds as an integer.
Description	This command will set the integration period for standby power mode. (See page 41, <i>Standby power mode</i> .) Since this command works with a group, use the :INST:NSEL command first to select the active group.
Syntax	:MOD:SBY:PER?
Return	Integration period for the selected group.
Description	This command will return integration period for the active group. Since this command works with a group, use the :INST:NSEL command first to select the active group.

:MOD:INT Integrator mode

Syntax	:MOD:INT:ST:METH <method> Where < method > 0 = manual 1 = clock 2 = level NOTE: Since the integrator is a group function, use the :INST:NSEL command first to select the active group.
Description	Sets the starting method for the integrator.
Syntax	:MOD:INT:ST:CLK:TIME <time> Where <time> is either hh:mm:ssA/P or :hh:mm:ss.
Description	Sets integrator start time when used in clock start method. Data in input in the same format as the user has requested.
Syntax	:MOD:INT:ST:CLK:DATE <date> Where <date> is either dd:mm:yyyy or :mm:dd:yyyy or yyyy:mm:dd.
Description	This will set integrator start date when used in clock start method. Data in input in the same format as the user has requested.
Syntax	:MOD:INT:ST:LVL:CH <channel> Where <channel> is 1 through 4
Description	Sets the channel to use for level trigger. Specified as 1,2, 3 or 4. If the channel number is not valid, then the ESR bit will be set.
Syntax	:MOD:INT:ST:LVL:SIG: <measurement> Where <measurement> is the measurement as defined in the :SEL command. (See page 68, :SEL.)
Description	Sets the signal to be monitored for comparison against the threshold. The command is followed by the normal signal selection parameter such as VRMS or PWF.
Syntax	:MOD:INT:ST:LVL:THRES <threshold>
Description	Set the threshold level. A float from $\pm 1E9$.

Integrator mode (cont.)

Syntax	:MOD:INT:ST:LVL:DIR <direction> Where <direction> is 0 for "≥" and 1 for "≤"
Description	Sets the direction of signal change when using level trigger start.
Syntax	:MOD:INT:DUR <duration> Where <duration> is the time in minutes
Description	Sets the duration for integration. Value of 0.0 to 10,000.
Syntax	:MOD:INT:PF <power factor"> Where <power factor"> is the desired power factor in the range of +1 to -1
Description	Sets the desired power factor for correction VArS. Value of +1.0 to -1.0.
Syntax	:MOD:INT:RUN
Description	Starts integration for the currently selected group.
Syntax	:MOD:INT:STOP
Description	Stops integration on all running integrators.
Syntax	:MOD:INT:RESET
Description	Resets integration for the currently selected group.

:MOD:PWM PWM motor mode

NOTE: There are no specific PWM Motor mode command other than the normal :MOD:PWM command to select PWM Motor mode.

Input setup commands

The input setup commands correspond to the Inputs menu. (See page 44, *Inputs*.) They are used to control how signal inputs to the PA4000 are channelled and controlled.

:WRG Wiring configuration

Syntax	:WRG:1P2 - Set 1 phase, 2 wire :WRG:1P3 - Set 1 phase, 3 wire :WRG:3P3 - Set 3 phase, 3 wire :WRG:3P4 - Set 3 phase, 4 wire
Description	Sets up the wiring configuration for the group currently selected. Use the :INST:NSEL command first to select the active group.

:NAME Group name

Syntax	:NAME <value> Where <value> = 8 characters for group name
Description	This command will set the display name for the group. The limit is 8 characters, per group name. Since this command works with a group, use the :INST:NSEL command first to select the active group.
Syntax	:NAME? Where <value> = 8 characters for group name
Return format	Group name up to 8 characters.
Description	This command will return the display name for the active group. Since this command works with a group, use the :INST:NSEL command first to select the active group.

:RNG Ranging

Syntax	:RNG:VLT AMP:FIX <range> :RNG:VLT AMP:AUT VLT = set voltage ranging AMP = set current ranging FIX = Fixed ranging AUT = auto ranging Where <range> = range number from 1 to 12.			
Description	Sets the range for the currently selected group, Use the :INST:NSEL command first to select the active group. The range numbers for each input are defined below:			
Range #	Volts	30 A shunt	1 A shunt	Ext. shunt
Auto				
3	2 V	0.2 A	0.005 A	0.003 V
4	5 V	0.5 A	0.0125 A	0.0075 V
5	10 V	1 A	0.025 A	0.015 V
6	20 V	2 A	0.05 A	0.03 V
7	50 V	5 A	0.125 A	0.075 V
8	100 V	10 A	0.25 A	0.15 V
9	200 V	20 A	0.5 A	0.3 V
10	500 V	50 A	1.25 A	0.75 V
11	1000 V	100 A	2.5 A	1.5 V
12	2000 V	200 A	5 A	3 V
Syntax	:RNG:VLT AMP?			
Return	0 through 12.			
Description	Returns the range configuration that applies to the currently selected group. If the currently selected group is in auto-range, then 0 will be returned.			

Ranging (cont.)

Syntax	:RNG:VLT AMP:AUT?
Return	0 through 12.
Description	Note: This command is linked to a channel, not a group. Returns the actual range that the currently selected channel is in. When there are multiple channels in a group, and the group is set to auto range, channel will find the best range for signals applied. Use the :INST:NSEL command first to select the active channel.

:SHU Shunt selection

Syntax	:SHU:INT :SHU:INT1A :SHU:EXT INT = set internal 30 Arms shunt INT1A = set internal 1 Arms shunt EXT = set external shunt
Description	Sets the shunt for all channels in the currently selected group. Use the :INST:NSEL command first to select the active group.
Syntax	:SHU?
Return format	0 through 2.
Description	Returns the shunt setting for the currently selected group. 0 = Internal 30 Arms shunt 1 = Internal 1 Arms shunt 2 = External shunt Use the :INST:NSEL command first to select the active group.

:FSR Frequency settings

Syntax	:FSR:VLT :FSR:AMP :FSR:EXT1 :FSR:EXT2 VLT = set the voltage channel as the source INT1A = set current channel as the source EXT1 = set external counter input 1 as the source EXT2 = set external counter input 2 as the source
Description	Sets the frequency source the currently selected group. The first channel in the group will be used to determine the frequency. Use the :INST:NSEL command first to select the active group.
Syntax	:FSR?

Frequency settings (cont.)

Return	0 through 3
Description	Returns the currently configured frequency source for the selected group. The values returned correspond to: 0 = Voltage channel 1 = Current channel 2 = External counter input 1 3 = External counter input 2 Since this command works with a group, use the :INST:NSEL command first to select the active group.
Syntax	FSR:PHR:VLT - Set the voltage channel the reference. :FSR:PHR:AMP - Set the current channel as the reference.
Description	Sets the phase reference for the group to be either the voltage or the current channel of the first card in the group. This command works on a group. Use the :INST:NSEL command first to select the active group.
Syntax	:FSR:PHR?
Return	0 through 1
Description	Returns the currently configured phase reference for the selected group. The values returned correspond to: 0 = Voltage channel 1 = Current channel Since this command works with a group, use the :INST:NSEL command first to select the active group.
Syntax	:FSR:RNG <value> Where <value> = 0 through 3
Description	Sets the frequency range allowed for the input signal. The values correspond to: 0 = 10Hz to 50kHz 1 = >10Hz 2 = 1 to 100Hz 3 = 0.1Hz to 10Hz This command works on a group. Use the :INST:NSEL command first to select the active group.
Syntax	:FSR:RNG?

Frequency settings (cont.)

Return	0 through 3
Description	Returns the currently configured frequency range for the selected group. The values returned correspond to: 0 = 10Hz to 50kHz 1 = >10Hz 2 = 1Hz to 100Hz 3 = 0.1Hz to 10Hz Since this command works with a group, use the :INST:NSEL command first to select the active group.

:BDW Bandwidth

Syntax	:BDW <value> Where <value> = 0 or 1.
Description	Sets the bandwidth of all voltage and current measurement channels in the active group. 0 = high bandwidth and 1 = low bandwidth. Low bandwidth mode introduces a 10 kHz 2-pole filter into the voltage and current measurement channels.
Syntax	:BDW?
Return	0 through 1
Description	Returns the currently configured bandwidth for the selected group. The values returned correspond to: 0 = High bandwidth 1 = Low bandwidth Since this command works with a group, use the :INST:NSEL command first to select the active group.

:SCL Scaling

Syntax	:SCL:VLT AMP EXT <scale> :SCL:VLT AMP EXT:GRP <scale> VLT = Voltage channel scaling AMP = Current channel scaling EXT = External shunt scaling Where <scale> = number from 0.00001 to 100000.
Description	Sets the scaling factor for the currently selected channel. Use the :INST:NSELC command first to select the active channel. If the GRP option is used then the same scaling factor will be applied to all channels in the group.

Scaling (cont.)

Syntax	:SCL:VLT AMP EXT? VLT = Voltage channel scaling AMP = Current channel scaling EXT = External shunt scaling
Return	Number from 0.00001 to 100000
Description	Note: THIS COMMAND IS LINKED TO A CHANNEL, NOT A GROUP. Returns the scaling factor for the currently selected channel. Use the :INST:NSELC command first to select the active channel.

:ANA Analog inputs

Syntax	:ANA <input>,<range> Where: <input> = input number 1 through 4 <range> = 1 or 10
Return	none
Description	Sets up the analog inputs 1 though 4. If <range> is 1 then the ± 1 V range selected. If <range> is 10, then the ± 10 V range is selected for the specified input.
Syntax	:ANA? <input> Where: <input> = input number 1 through 4
Return	Measured value
Description	Returns the measured analog signal on the selected input.

Graph and waveform commands

Currently not implemented.

Interface commands

Interface commands are used to set up and control the various ways of communicating with the PA4000.

:COM:RS2 RS232 configuration

Syntax	:COM:RS2:BAUD <baud rate> Where <baud rate> = baud rate of 9600, 19200 or 38400.
Description	Sets the RS232 baud rate.
Syntax	:COM:RS2:BAUD?

RS232 configuration (cont.)

Return	baud rate of 9600, 19200 or 38400
Description	Returns the RS232 baud rate.

:COM:IEE GPIB configuration

Syntax	:COM:IEE:ADDR <address> Where <address> = address in the range of 1 to 30.
Description	Sets the GPIB address for the PA4000.
Syntax	:COM:IEE:ADDR?
Return	address in the range of 1 to 30.
Description	Returns the GPIB address for the PA4000. If -1 is returned, then there is no GPIB card installed.

:COM:ETH Return Ethernet configurations

Syntax	:COM:ETH:SUB IP GATE? SUB = Subnet mask IP = IP address GATE = Default gateway
Return	Number in the form of v4 IP address xxx.xxx.xxx.xxx.
Description	Returns the requested information in the form of an IP address. The information returned is the current configuration. If DHCP is used as the assignment method, then the values returned would be those values assigned by the DHCP server.

:COM:ETH:STAT Static Ethernet configuration

Syntax	:COM:ETH:STAT <value> Where <value> = 0 or 1
Description	Determines whether the PA4000 uses a static IP address or one assigned by a DHCP server. If <value> = 0 then a DHCP server is used. If <value> = 1 then the static IP settings are used.
Syntax	:COM:ETH:STAT?
Return	0 or 1
Description	Returns whether the PA4000 uses a static IP address or one assigned by a DHCP server. If the returned value is 0 then a DHCP server is used. If the returned value is a 1 then the static IP settings are used.

Static Ethernet configuration (cont.)

Syntax	:COM:ETH:STAT:SUB IP GATE <ip value > SUB = Subnet mask IP = IP address GATE = Default gateway Where <ip value> is in the format xxx.xxx.xxx.xxx.
Description	These commands are used to set the statically assigned IP values for the PA4000.
Syntax	:COM:ETH:STAT:SUB IP GATE? SUB = Subnet mask IP = IP address GATE = Default gateway
Return	IP address in the format xxx.xxx.xxx.xxx
Description	These commands are used to return the statically assigned IP values for the PA4000.

:COM:ETH:MAC**Ethernet MAC Address**

Syntax	:COM:ETH:MAC? MAC = MAC address
Return	MAC address in the format of 12 HEX characters.
Description	Used to return the MAC address on the Ethernet controller. The MAC address would be of the form: 0x0019B9635D08.

Datalog command

The datalog commands produce the same functionality as the Datalog menu and as the [DATA OUT (DATA DUMP)] key on the front panel.

:DATA:USB**USB Datalogging**

Syntax	:DATA:USB <stop/start> Where <stop/start> - 0 = stop; 1 = start
Return	none
Description	This command has the same function as pressing the [DATA OUT (DATA DUMP)] key. It will, if a USB memory stick is present and the USB / Ethernet card is installed, log data to the device.

Math commands

The math commands enable the setting up of the math screen on the PA4000 as well as the returning of the results.

:MATH:FUNC

Math function information

Syntax :MATH:FUNC <func number="">,<name>,<formula >,<unit>

Where: <func number>= 1 through 30

<name> = User visible name

<formula> = formula for math function

<unit> = units to be displayed

Return 1 if successful, otherwise 0.

Description Configures the specified math function.

Syntax :MATH:FUNC? <func. Number">

Where :<func. Number> is a valid math function number between 1 and 30.

Return <name> = User visible name

<formula> = formula for math function

<unit> = units to be displayed

Description This command will returned the math function name, formula and units for a specified function.

:MATH:FUNC:EN

Syntax :MATH:FUNC:EN <func. Number>,<enable >

Where <func. Number> is a valid math function number between 1 and 30.

<enable> is 1 to enable the display of the function and 0 to disable it.

Return None

Description This command will enable or disable math function in the Math screen.

Syntax :MATH:FUNC:EN? <func. Number">

Where <func. Number"> is a valid math function number between 1 and 30.

Return 0 = function disabled; 1 = function enabled.

Description This command will return the status of whether a math function is enabled or disabled.

:MATH?

Return MATH results

Syntax :MATH?

Return results

Description This command returns all the calculated math functions that are enabled in a comma-separated string.

System configuration commands

The System configuration commands correspond to the System Configuration front panel menu screen. (See page 55, *System configuration*.)

:BLK Blanking

Syntax	:BLK:ENB - blanking enabled. :BLK:DIS – blanking disabled.
Return	None
Description	With blanking enabled, the analyzer will return a zero when the measured signal is less than 5% of the bottom range for the selected channel. If the blanked channel is also used in another result i.e. Watts, then that value will also be blanked.
Syntax	:BLK?
Return	“ENB” if enabled; “DIS” if disabled.
Description	Returns the status of blanking.

:AVG Averaging

Syntax	:AVG:AUT <depth> Where <depth> is 1 through 10.
Return	None
Description	The command sets up the depth of the averaging buffer to average up to <depth> sample periods. The sample period can also be changed using the UPDATE command. The averaging buffer will be reset whenever there is a range change or, if, the channel is currently on the bottom range, then the buffer will be reset upon a 10% of range change.
Syntax	:AVG?
Return	The averaging value as an integer.
Description	Returns the units averaging value.

:UPDATE Update rate

Syntax	:UPDATE <update rate> Where <update rate> is 0.2 to 2.0 seconds in tenth of a second intervals.
Return	None
Description	Change the display update rate. If the update rate is set below 0.5 seconds, then the number of harmonics returned in the update period will be reduced.
Syntax	:UPDATE?
Return	The update rate as a float.
Description	Returns the units update value.

:SYST:ZERO Auto zero

Syntax	:SYST:ZERO <value> Where <value> is 0 for disable, 1 for enable, and 2 to run immediately.
Return	None
Description	Sets whether the auto zero function for the channels is enabled or disabled.

:SYST:DATE System date

Syntax	:SYST:DATE? :SYST:DATE:SET <date value> :SYST:DATE:FORMAT <date format> Where <date value> is the new date in the selected format and <date format> is the date format.
Return	Date formatted in the way specified by the user separated by “.”.
Description	The :SYST:DATE? Command will return the date on the analyzer in the format specified by the user. The user can choose one of 3 formats: <date format> = 0 – mm:dd:yyyy <date format> = 1 – dd:mm:yyyy <date format> = 2 – yyyy:mm:dd The user can also set the date on the analyzer using the :SYST:DATE:SET command. In this case, the <date value> should be in the format specified. For example, if the specified format were 0 (mm-dd-yyyy), then the command would be: :SYST:DATE:SET 12:31:2011

:SYST:TIME **System time**

Syntax	:SYST:TIME? :SYST:TIME:SET <time value > :SYST:TIME:FORMAT <time format> Where <time value> is the new time in the selected format and <time format> is the time format.
Return	Time formatted in the way specified by the user, hours and minutes and seconds separated by ":". For example, 01:34:22P for 12 hour or 13:34:22 for 24 hour.
Description	The :SYST:TIME? command will return the time on the analyzer in the format specified by the user. The user can choose one of 3 formats: <time format> = 0 – 12 Hour hh:mm:ss A/P <time format> = 1 – 24 Hour hh:mm:ss The user can also set the time on the analyzer using the :SYST:TIME:SET command. In this case, the <time value> should be in the formatted specified. For example, if the specified format were 0 (12 Hour), then the command would be: :SYST:TIME:SET 08:32:20 P For 12 hour clock, A should be used for AM and P for PM.

:SYST:POWER **Power usage**

Syntax	:SYST:POWER:DISP <value> Where: <value> is 1, 2 or 3.
Return	None
Description	This command allows the display to be switched off to reduce the power consumption of the analyzer. The operation of the display is determined by <value> 0 = always on 1 = off after 10 minutes with no key press or comms 2 = off in remote control mode.

User configuration commands

These commands relate to the User Configuration menu item.

:CFG:USER **User configurations**

Syntax	:CFG:USER:LOAD <value> :CFG:USER:SAVE <value> Where: <value> is user configuration 1 through 8 for saving and 0 through 8 for loading. 0 is the default configuration.
--------	--

Return	1 for success, 0 for failure.
--------	-------------------------------

Description	These commands will be used to load and save one of the 8 user configurations.
-------------	--

Syntax	:CFG:USER:REN <value>,< config. Name> Where <value> is user configuration 1 through 8. <config. Name> is a new configuration name (up to 16 characters).
--------	--

Return	None.
--------	-------

Description	This command is used to change the name of the configuration to aid a user in finding it again. Tip: Allow between 15 – 20 seconds after :CFG:USER:LOAD 0 has been sent prior to reading a 1 for success, or 0 for failure. Also depending on the configuration being saved and/or loaded allow between 15 – 20 seconds after sending these commands before again reading a 1 for success or 0 for failure.
-------------	--

Sending and receiving commands

As stated before, there are many ways in which to send commands to the PA4000, but there are some common rules for all methods:

- All instructions should be terminated with a line feed (ASCII 10) character.
- All returned information will be terminated by a line feed (ASCII 10) character.
- Only one instruction can be sent at a time. ":SEL:VLT;:SEL:AMP" is not a valid command.

- For all commands that configure the unit, allow 0.5 seconds between each command or use flow control to wait until the next command is sent.
- The running of auto-zero, which happens every 1 minute, will result in no new results for approximately 1 second. For this reason auto-zero can be disabled.

NOTE. When utilizing communications via the Ethernet interface on the PA4000, all communications will be responded to with a carriage return character, i.e. ASCII CR (0x0D). In the examples below the carriage return character is represented by “[CR]”.

Tip. If using Visual Studio or Lab-View you can utilize the ‘Flush, In-buffer’ command to quickly and simply remove the carriage return from the input buffer. This can be set-up as a discipline in the software to occur after every read and write command sent.

Example 1. User sends a query to the PA4000 to determine the status of the shunt. The PA4000 will respond with a CR added to the end of the string;

USER: “:SHU?”

PA4000: “0[CR]”

The PA4000 responds as normal with a CR character added to the end of the string.

Example 2. User sends a command to the PA4000 to disable blanking and the PA4000 responds with a CR character;

USER: “:SHU:INT”

PA4000: “[CR]”

The PA4000 responds with a CR character.

Utilizing all other communication methods the PA4000 does not reply with a CR to every communication.

Communications examples

Basic selection and returning of result

The results are returned using the FRD command. This returns the results that are shown on the screen, in the order in which they appear on the screen. As results are selected using comms, the results are added to the bottom of the list, with the exception of harmonics, which always appear at the end of the list.

:INST:NSEL 1	Sets the current group as group 1
:SEL:CLR	clears all results from all groups
:SEL:VLT	
:SEL:AMP	

:SEL:FRQ	
:SEL:WAT	
:SEL:VAS	
:SEL:VAR	
:SEL:PUF	
:SEL:VPK+	
:SEL:APK+	
:FRD?	Returns Vrms, Arms, Frequency, Watts, VA, Var, power factor, Vpeak + and Vpeak- in floating point format.
:FRF?	Returns the results selected for confirmation using the label that appears on the display. In this case will return, "Vrms, Arms, Freq, Watt, VA, Var, PF, Vpk+, Apk+

Returning results repeatedly

The PA4000 updates the results at the specified update rate. To return results as soon as they are available, set up the DSE register to enable bit 1, the New Data Available (NDV) bit. Then read the DSR register using the ":DSR?" command until it indicates that there is new data available, and then send a ":FRD?" command to get selected results.

":DSE 2" // This enables the NDV bit.

While strDSR <> "2"

 ":DSR?"

 strDSR = received data

WEND

":FRD?"

Receive results

Harmonics

To return harmonics, first the number of harmonic and the scope need to be selected and then they need to be added to the list of results on the display.

:HMX:VLT:SEQ 0	Select odd and even harmonics (use 1 to select odd harmonics only).
----------------	---

:HMX:VLT:RNG 9	Return all harmonic from 1 to 9.
----------------	----------------------------------

:SEL:VHM	Add Voltage harmonics to the list.
----------	------------------------------------

Now, assuming :SEL:CLR has not been issued after example 1, then the following results would be returned by :FRD?

Vrms, Arms, Freq, Watt, VA, Var, PF, Vpk+, Apk+, Vh1 Mag, Vh1 phase, Vh2 Mag, Vh2 phase, Vh9 Mag, Vh9 phase.

Communication example using a group of channels

Example showing a full sequence of commands used to communicate with a group of channels. This example will use the 1 A shunt and will blank below 5% of the range.

*RST	(resets the instrument to default values)
*IDN?	(identifies the instrument, returns a string that can be used by the user in the software "Tektronix, PA4000, Serial Number, Firmware Version").
:INST:NSEL 1	(selects group 1)
:WRG:3P3	(sets channel 1 and channel 2 for 3 phase 3 wire set-up as part of group 1).
:RNG:VLT:AUT	(sets voltage auto ranging)
:RNG:AMP:AUT	(sets current auto ranging)
:SHU:INT1A	(sets 1A shunt for current measurements)
:FSR:VLT	(sets voltage as the frequency source)
:BLK:ENB	(enables blanking)
:AVG:AUT	(sets auto averaging)
:SEL:CLR	(clears the measurement selection list)
:SEL:VLT	(selects vrms)
:SEL:WAT	(selects watts power)
:SEL:AMP	(selects arms)
:SEL:FRQ	(selects frequency)
:SEL:PWF	(selects power factor)
:SEL:VAS	(selects VA power)
{ }	
{ Any additional parameters such as harmonics enter here. (See page 92, <i>Harmonics</i> .) }	
{ }	
:DSE 3	(sets DSR for new data available and data available)
While dsr <> 3	(polls in a continuous loop until DSR = 3)
:DSR?	
Loop	
:FRD:GRP 1?	(reads the measured data, which will be shown as follows in floating point format: -)
(Vrms, Watts, Arms, Freq, Power Factor, VA Power, Vrms, Watts, Arms, Freq, Power Factor, VA Power).	

Software

PA4000 download software

The PA4000 has been designed so that the user can add new features simply by updating the firmware within the product. The firmware is updated by using a free PC software program. This program can be found on the PA4000 section of Tektronix's web site (www.Tektronix.com). Simply download the software and install it on your PC.

The download software is compliant with Windows XP, Vista and 7.

Once installed, run the software to get the main screen:

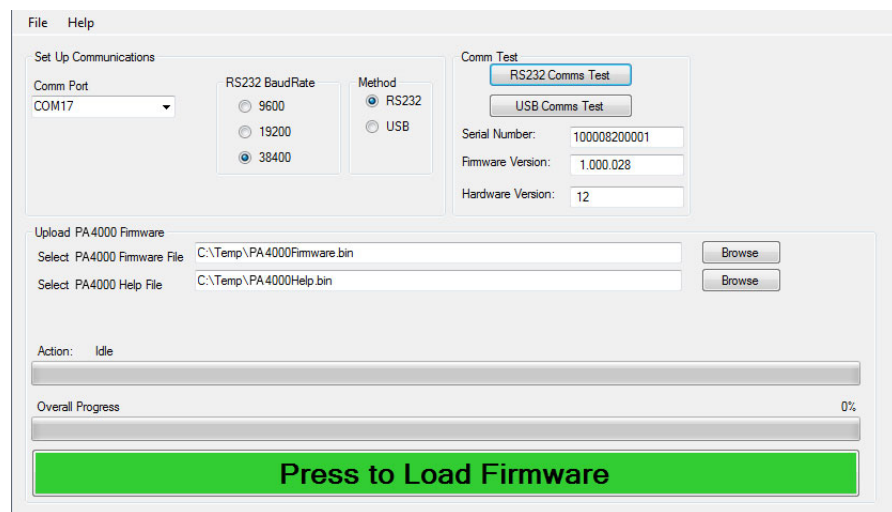

The software supports the downloading of firmware via RS232 and USB.

Before downloading code, you need to select the RS232 port on your PC and ensure that the baud rate selected matches the baud rate on the PA4000. This can be found under the Interface menu option. (See page 51, *Interfaces*.) You can confirm that the comms interface has been setup correctly by clicking on the RS232 Comms Test button. This will return the serial number, firmware version and hardware version of the PA4000. Alternatively you can select USB under method and click USB Comms Test.

Next, you need to point the software to both the main firmware file and the help file. These files will be named "PA4000Firmware.bin" and "PA4000Help.bin" respectively. The file can also be found on Tektronix's website on the PA4000 page.

Finally, when ready, click on “Press to Load Firmware”.



CAUTION. *Do not remove power from the PA4000 during the download.*

During the final section of the download, the PA4000 screen will go blank and the blue [SHIFT] LED will blink. Once the download is complete, the PA4000 will restart automatically and will then be ready for use.

Specifications

Measurement channel

Voltage connections

- Measurements to 1000 V_{rms}, DC to 1 MHz, continuous
- Differential input impedance: 1 Mohm in parallel with 13 pF
- High and low input impedance to ground: 30 pF

30 A current connection

- Measurements to 200 A_{pk}, 30 A_{rms}, DC to 1 MHz, continuous
- 15 A_{rms} maximum with the unit switched off, or when the selected shunt is not the 30 A shunt
- 75 A_{rms} for 1 second non-repetitive
- 9.375 mΩ
- High and low input impedance to ground: 45 pF

1 A current connection

- Measurements to 5 A_{pk}, 1 A_{rms}, DC to 1 MHz, continuous
- 2 A_{rms} for 1 second non-repetitive
- 0.6 Ω
- High and low input impedance to ground: 45 pF
- Protection = T1.0AH, 250 V, 5 x 20 mm fuse (time-delayed, high breaking capacity)

External current connection

- Measurements to 3.0 V_{pk}, DC to 1 MHz, continuous
- 50 V_{pk} for 1 second
- High and low input impedance to ground: 45 pF

Analog card power supply outputs (optional)

- ±15 V supply
- ±15 V ±5%, 250 mA max (protected) per analog card output

Power input

- AC input voltage = 100 - 240 V, 50 to 60 Hz
- Protection = T4AH, 250 V, 5 x 20 mm fuse (time-delayed, high breaking capacity)
- Consumption = 120 VA max.

Mechanical and environmental

- Dimensions (Approx.)**
- Height: 13.2 cm (5.2") without feet, 14.6 cm (5.75") with feet
 - Width: 42 cm (16.5")
 - Depth: 31 cm (12.5")

- Weight (Approx.)** 8.8 Kg (19.5 lb) for 4 phase instrument with +15 V supply and the GPIB options installed.

- Dielectric strength**
- Mains supply inlet (Live + Neutral to earth): 1.5 kVAC
 - Voltage measurement inputs: 2 kV_{pk} to earth
 - Current measurement inputs: 2 kV_{pk} to earth

- Storage temperature** -20 °C to +60 °C

- Operating temperature** 0 °C to 40 °C

- Maximum operating altitude** 2000 M

- Maximum relative humidity** 80 % for temperatures up to 31 °C decreasing linearly to 50 % relative humidity at 40 °C

Optional parts

- GPIB card** The GPIB card enables the PA4000 to be control using the industry standard IEEE 488 instrument protocol.

This option (Opt. GPIB) is factory installed.

Transducer power supply The PA4000 can have an optional ± 15 V supply for use with external transducers. The supply is capable of supplying 250 mA per rail, per analog card.
This option (Opt. 15V) is factory installed.

Communication ports

The PA4000 is fitted with RS232, Ethernet, and USB as standard.

- Serial port**
- 9 pin male D-type connector on rear of instrument
 - RS232 Interface for connection to a PC for remote control with a straight through cable
 - Available baud rates 9600, 19200, (default) 38400
 - 8 bit, No parity, 1 stop bit, hardware flow control

Pin	I/O	Signal name	Pin	I/O	Signal name
1		No connection	6		No connection
2	Out	TXD	7	In	CTS
3	In	RXD	8	Out	RTS
4		No connection	9		No connection
5		0 V			

IEEE 488 / GPIB (optional) The IEEE 488 port is compatible with 488.2 Normal GPIB cables will work with the PA4000.

Pin	Signal name	Pin	Signal name
1	Data 1	13	Data 5
2	Data 2	14	Data 6
3	Data 3	15	Data 7
4	Data 4	16	Data 8
5	End or Identify (EOI)	17	Remote Enable (REN)
6	Data Valid (DAV)	18	GND
7	Not Ready For Data (NRFD)	19	GND
8	Not Data Accepted (NDAC)	20	GND
9	Interface Clear (IFC)	21	GND

Pin	Signal name	Pin	Signal name
10	Service Request (SRQ)	22	GND
11	Attention (ATN)	23	GND
12	Shield Ground	24	GND

USB host

- 2 ports. One on the front and one on the rear.
- Front port is always fitted, but needs optional card for functionality.
- Rear port does not support USB flash drives. Only available on the front port.
- 250 mA, +5 V supply per port.

USB Flash Drive Requirements:

- The USB flash drive must be formatted with FAT12, FAT16 or FAT32 file systems.
- Sector size must be 512 bytes. Cluster size up to 32kB.
- Only Bulk Only Mass Storage (BOMS) devices which support the SCSI or AT command sets are supported. For more information on BOMS devices refer to Universal Serial Bus Mass Storage Class – Bulk Only Transport Rev. 1.0, published by the USB Implementers Forum.

Pin	Description
1	+5 V (o/p)
2	D- (i/p and o/p)
3	D+ (i/p and o/p)
4	0V (o/p)

USB peripheral

- USB 2.0 compatible. Will work with any USB 2.0 system.
- Full Speed (12 Mbits/sec).

Pin	Description
1	VBus (i/p)
2	D- (i/p and o/p)
3	D+ (i/p and o/p)
4	0 V (i/p)

- Ethernet port**
- IEEE 802.3 compatible, 10Base-T
 - Connector: RJ-45 with Link and Activity indicators
 - TCP/IP connection on port 5025

Pin	Signal name
1	Tx+
2	Tx-
3	Rx+
4	Common
5	Common
6	Rx-
7	Common
8	Common

Status indicator LEDs:

- Green – Connection established
- Yellow – Data activity

Auxiliary inputs/outputs

The PA4000 is fitted with a number of auxiliary inputs and outputs. They are:

- 4 Analog inputs
- 2 counter inputs
- 4 digital outputs

The pin connections on the auxiliary connect are:

Pin	Signal name	Pin	Signal name
1	Analog Input 1	7	Digital Output 3
2	Analog Input 2	8	Digital Output 4
3	Analog Input 3	9	Counter Input 1
4	Analog Input 4	10	Counter Input 2
5	Digital Output 1		
6	Digital Output 2		

Pins 11 through 22 are connected to ground. Pins 23 through 25 have no connection.

Analog inputs	Each analog input will accept a signal of +10 V to -10 V. Each input is fitted with protection diodes limiting the input signal to ± 12 V.
Counter inputs	Each counter input will accept +10 V to -10 V. Each input is fitted with protection diodes limiting the input signal to ± 12 V. The signal must be less than 0.5 V or lower to be counted as a zero and greater than 1.5 V to be counted as a 1. The duty cycle is 20% to 80%.
Digital outputs	Each digital output is +5 V TTL compliant with 10 k Ω of output impedance.

Host/Client port

No user connections. Functionality not yet implemented.

Measured parameters

Table 1: Phase measurements

Abbreviation	Description	Units	Formula
V_{RMS}	RMS Voltage	Volt (V)	$V_{RMS} = \sqrt{\frac{1}{T} \int_0^T v_1^2 dt}$
A_{RMS}	RMS Current	Amp (A)	$A_{RMS} = \sqrt{\frac{1}{T} \int_0^T i_1^2 dt}$
F	Frequency	Hertz (Hz)	
W	True Power	Watt (W)	$W = \frac{1}{T} \int_0^T v_i i_i dt$
PF	Power factor		$PF = \left[\frac{Watt}{V_{rms} \times A_{rms}} \right]$
VA	Apparent Power	Volt-Amps (VA)	$VA = [V_{rms} \times A_{rms}]$
VAr	Reactive Power	Volt-Amps Reactive (VAr)	$VAr = \sqrt{(VA)^2 - W^2}$
V_{PK+}	(+)ve Peak Voltage	Volt (V)	$max \{v\}$
V_{PK-}	(-)ve Peak Voltage	Volt (V)	$min \{v\}$
A_{PK-}	(+)ve Peak Current	Amp (A)	$max \{i\}$
A_{PK+}	(-)ve Peak Current	Amp (A)	$min \{i\}$

Table 1: Phase measurements (cont.)

Abbreviation	Description	Units	Formula
V _{DC}	DC Voltage	Volt (V)	$V_{DC} = \frac{1}{T} \int_0^T v dt$
A _{DC}	DC Current	Amp (A)	$A_{DC} = \frac{1}{T} \int_0^T i dt$
V _{RMN}	Rectified Mean Voltage	Volt (V)	$V_{MEAN} = \frac{1}{T} \int_0^T v dt$
A _{RMN}	Rectified Mean Current	Amp (A)	$A_{MEAN} = \frac{1}{T} \int_0^T i dt$
V _{CF}	Voltage Crest Factor		$CF = \frac{Peak\ Value}{RMS\ Value}$
A _{CF}	Current Crest Factor		$CF = \frac{Peak\ Value}{RMS\ Value}$
V _{THD}	Voltage Total Harmonic Distortion	%	$\frac{\sqrt{(H0^2)+H2^2+H3^2+H4^2+H5^2+....}}{REF}$
V _{DF}	Voltage Distortion Factor	%	$\frac{\sqrt{V_{rms}^2-H1^2}}{REF}$
V _{TIF}	Voltage Telephone Influence Factor		$\frac{1}{V_{ref}} \sqrt{\sum_{min\ harm}^{max\ harm} (k_n \times V h_n)^2}$
A _{THD}	Current Total Harmonic Distortion	%	$\frac{\sqrt{(H0^2)+H2^2+H3^2+H4^2+H5^2+....}}{REF}$
A _{DF}	Current Distortion Factor	%	$\frac{\sqrt{A_{rms}^2-H1^2}}{REF}$
A _{TIF}	Current Telephone Influence Factor		$\frac{1}{A_{ref}} \sqrt{\sum_{min\ harm}^{max\ harm} (K_n \times A h_n)^2}$
Z	Impedance	Ohm (θ)	$Z = \frac{V_{fund}}{I_{fund}}$
R	Resistance	Ohms (Ω)	$R = \frac{V_f}{A_f} \times \cos \theta (\theta = V\ phase - A\ phase)$
X	Reactance	Ohms (Ω)	$X = \frac{V_f}{A_f} \times \sin \theta (\theta = V\ phase - A\ phase)$

Table 1: Phase measurements (cont.)

Abbreviation	Description	Units	Formula
Vf	Fundamental Voltage	Volts (V)	$\sqrt{(V1.r^2 + V1.q^2)}$
Af	Fundamental Current	Amps (A)	$\sqrt{(A1.r^2 + A1.q^2)}$
Wf	Fundamental Power	Watts (W)	$V1.r \times A1.r + V1.q \times A1.q$
VAf	Fundamental Apparent Power	Volt-Amps (VA)	$\sqrt{W.fund^2 + VAr.fund^2}$
VArf	Fundamental Reactive Power	Volt-Amps Reactive (VAR)	$if W > 0$ $(V1.r \times A1.q) - (V1.q \times A1.r)$ $if W < 0$ $(V1.q \times A1.r) - (V1.r \times A1.q)$
PFf	Fundamental Power Factor		$\frac{W.fund}{VA.fund}$
CorrVArS	Correction VArS	VA	$W_{fund} \times [\tan(\cos^{-1}(Desired PF)) - \tan(\cos^{-1}(PFf))]$
Vh _n	Voltage harmonic n	Volt (V)	$Mag = \sqrt{(Vh_n.r^2 + Vh_n.q^2)}$ $Phase = \tan^{-1}\left(\frac{Vh_n.q}{Vh_n.r}\right)$
Ah _n	Current harmonic n	Amp (A)	$Mag = \sqrt{(Ah_n.r^2 + Ah_n.q^2)}$ $Phase = \tan^{-1}\left(\frac{Ah_n.q}{Ah_n.r}\right)$
Wh _n	Watts harmonic n	Watt (W)	$Mag = Vh_n \times Ah_n \times \cos(Ap_n - Vp_n)$

¹ f = real part of fundamental V or I fundamental
q=imaginary or quadrature part of V or I
V and I fundamental are complex numbers in the form r+jq

One phase, three wire SUM formulae

$$\sum V = \frac{ch1V + ch2V}{2}$$

$$\sum V.fund = \frac{ch1V.fund + ch2V.fund}{2}$$

$$\sum W = ch1W + ch2W$$

$$\sum W.fund = ch1W.fund + ch2W.fund$$

$$*Note 1 \sum VAr = \sqrt{\sum VAr.fund^2 + \left(\sqrt{\frac{3}{2}} \times (ch1VAr.h + ch2VAr.h)^2\right)}$$

Three phase, four wire SUM formulae

Measurement accuracy

The table below lists the formulae for calculating the accuracy specification for each measurement.

In the equations below:

- It is assumed the waveform measured is a sine wave.
- F is the frequency measured in kHz. In case of harmonics, F is the harmonic frequency in kHz.
- V is the voltage measured in Volts.
- I is the current measured in Amps.
- Z_{EXT} is the external shunt impedance (0.6 Ω for 1 A shunt, 9.375 m Ω for 30 A shunt).
- Θ is the phase angle in degrees (i.e. phase of the current with reference to the voltage).

All specifications are valid 23 °C \pm 5 °C

Temperature coefficient \pm 0.02% of reading / °C, 0 to 18 °C, 28 to 40 °C.

Parameter	Specification
Voltage – V_{rms}, V_{rmn}, V_{dc}	
Ranges	2000 V, 1000 V, 500 V, 200 V, 100 V, 50 V, 20 V, 10 V, 5 V, 2 Vpeak
V_{rms} 45-850Hz Accuracy	\pm 0.04% of reading \pm 0.04% of range \pm 0.02 V
V_{rms} 10Hz – 45Hz, 850Hz – 1MHz, Accuracy	\pm 0.05% of reading \pm 0.05% of range \pm (0.02 * F)% of reading \pm 0.02 V
Vrmn	\pm 0.2% of reading \pm 0.1% of range \pm 0.1 V
DC Accuracy	\pm 0.05% of reading \pm 0.1% of range \pm 0.05 V
Effect of Common Mode	1000 V, 60 Hz < 10 mV 100 V, 100 kHz < 50 mV
Voltage — Harmonic magnitude and phase	
10 Hz – 1 MHz Accuracy	\pm 0.08% of reading \pm 0.08% of range \pm (0.02*F)% of reading \pm 0.02 V
Phase	\pm 0.025 \pm [0.005*(Vreading/Vrange)] \pm (0.05/Vrange) \pm (0.001*F)
Voltage – V_{pk+}, V_{pk-} crest factor	
Peak Accuracy	\pm 0.2% of Reading \pm 0.1% of Range + (0.01 * F)% of reading \pm 0.05 V – Low Bandwidth \pm 0.2% of Reading \pm 0.1% of Range + (0.01 * F)% of reading \pm 0.5 V – High Bandwidth
CF Accuracy	$\left[\frac{V_{PKerror}}{V_{PK}} + \frac{V_{RMSerror}}{V_{RMS}} \right] \times V_{CF}$ (valid for a crest factor of 1 to 10)

Parameter	Specification
Current – A_{rms}, A_{rnn}, A_{dc}	
30A Shunt Ranges	200 A, 100 A, 50 A, 20 A, 10 A, 5 A, 2 A, 1 A, 0.5 A, 0.2 A _{peak}
1A Shunt Ranges	5 A, 2.5 A, 1.25 A, 0.5 A, 0.25 A, 0.125 A, 0.05 A, 0.025 A, 0.0125 A, 0.005 A _{peak}
External Shunt Ranges	3 V, 1.5 V, 0.75 V, 0.3 V, 0.15 V, 0.075 V, 0.03 V, 0.015 V, 0.0075 V, 0.003 V _{peak}
A_{rms} 45-850 Hz Accuracy	$\pm 0.04\%$ of reading $\pm 0.04\%$ of range $\pm (20 \mu V / Z_{ext})$
10Hz – 45 Hz, 850 Hz – 1MHz Accuracy	$\pm 0.05\%$ of reading $\pm 0.05\%$ of range $\pm (0.02 * F)\%$ of reading $\pm (20 \mu V / Z_{ext})$
A_{rnn} Accuracy	$\pm 0.2\%$ of reading $\pm 0.1\%$ of range $\pm (100 \mu V / Z_{ext})$
DC Accuracy	$\pm 0.05\%$ of reading $\pm 0.1\%$ of range $\pm (50 \mu V / Z_{ext})$
Effect of Common Mode	1000 V, 60 Hz, 30 A shunt: < 1 mA 100 V, 100 kHz, 30 A shunt < 20 mA 1000 V, 60 Hz, 1 A shunt: < 50 uA 100 V, 100 kHz, 1 A shunt < 500 uA 1000 V, 60 Hz, external shunt: < 500 uA 100 V, 100 kHz, external shunt < 20 mV
Current – Harmonic magnitude and phase	
10 Hz - 1 MHz	$\pm 0.08\%$ of reading $\pm 0.08\%$ of range $\pm (0.02 * F)\%$ of reading $\pm (20 \mu V / Z_{ext})$
Phase	$\pm 0.025 \pm [0.005 * (A_{range} / A_{reading})] \pm (0.0001 / (A_{range} * Z_{ext})) \pm (0.001 * F)$
Current – A_{pk+}, A_{pk-}, crest factor	
Peak Accuracy	$\pm 0.2\%$ of Reading $\pm 0.1\%$ of Range + $(0.01 * F)\%$ of reading $\pm (0.3 \text{ mV} / Z_{ext}$ – Low Bandwidth $\pm 0.2\%$ of Reading $\pm 0.1\%$ of Range + $(0.01 * F)\%$ of reading $\pm (3 \text{ mV} / Z_{ext}$ – High Bandwidth
CF Accuracy	$\left[\frac{A_{PKerror}}{A_{PK}} + \frac{A_{RMSerror}}{A_{RMS}} \right] \times A_{CF}$ (valid for a crest factor of 1 to 10)
Frequency	
10Hz to 1MHz	0.05% of reading
0.1Hz to 10Hz	0.1% of reading
Power – W, VA, VAR, and PF	
W Accuracy	$(V_{rmsacc.} \times A_{rms} \times PF) \pm (A_{rmsacc.} \times V_{rms} \times PF) \pm (V_{rms} \times A_{rms} \times (\cos \theta - \cos \{\theta \pm (Vh1_{pherr} \pm Ah1_{pherr})\}))$
VA Accuracy	$(V_{rmsacc.} \times A_{rms}) + (A_{rmsacc.} \times V_{rms})$
VAR Accuracy	$\sqrt{(VA^2 - [W \pm W_{acc.}]^2)} - \sqrt{(VA^2 - W^2)}$
PF Accuracy	$\frac{W_{Accuracy}}{VA}$
Fundamental Power – Wf, Vaf, VARf, and Pff	

Parameter	Specification
Wf Accuracy	$(Vh1_{mag}acc. \times Ah1_{mag} \times PFf) \pm (Ah1_{mag}acc. \times Vh1_{mag} \times PFf) \pm (Vh1_{mag} \times Ah1_{mag} \times (\cos \theta - \cos \{\theta \pm (Vh1_{pherr} \pm Ah1_{pherr})\}))$
Vf Accuracy	$(Vh1_{mag}acc. \times Ah1_{mag}) + (Ah1_{mag}acc. \times Vh1_{mag})$
Vf Accuracy	$\sqrt{(VAf^2 - [Wf \pm Wfacc.]^2)} - \sqrt{(VAf^2 - Wf^2)}$
Pf Accuracy	$\frac{Wf_{Accuracy}}{VA}$
Distortion – DF, THD and TIF	
DF Accuracy	$\left[\frac{RMS_{error}}{RMS} + \frac{h1_{Mag}error}{h1_{Mag}} \right] \div DF$
THD Accuracy	$\left[\frac{h2_{Mag}error}{h2_{Mag}} + \frac{h3_{Mag}error}{h3_{Mag}} + \frac{h4_{Mag}error}{h4_{Mag}} + \dots etc \right] \times THD$
TIF accuracy	$\left[\frac{h1_{Mag}error \times k1}{h1_{Mag}} + \frac{h3_{Mag}error \times k3}{h3_{Mag}} + \dots + \frac{h71_{Mag}error \times k71}{h71_{Mag}} \right] \times THD$
Impedance – Z, R and X	
Z Accuracy	$\left[\frac{V_{RMS}error}{V_{RMS}} + \frac{A_{RMS}error}{A_{RMS}} \right] \times Z$
R Accuracy	$\left[\frac{Vh1_{mag}error}{Vh1_{Mag}} + \frac{Ah1_{Mag}error}{Ah1_{Mag}} + \left(\tan \theta \times (Vh1_{Pherror} + Ah1_{Pherror}) \times \frac{\pi}{180} \right) \right] \times R$
X accuracy	$\left[\frac{Vh1_{MAG}error}{Vh1_{MAG}} + \frac{Ah1_{MAG}error}{Ah1_{MAG}} + \left(\frac{Vh1_{Pherror} + Ah1_{Pherror}}{\tan \theta} \times \frac{\pi}{180} \right) \right] \times X$
Analog Inputs	
Ranges	10 Vdc range = ± 1 V to ± 10 V 1 Vdc range = ± 0.1 V to ± 10 V
Accuracy	$\pm 0.2\%$ of reading $\pm 0.2\%$ of range ± 0.005 V
Sample Rate	1000 samples per second

NOTE. Zext is the external shunt impedance used and must be less than or equal to 10 Ohms.

All the stated accuracies are based upon a minimum of a 30-minute warm up period.

If no frequency is measured, then the signal is considered DC for the purpose of accuracy.

Specifications are valid only when applicable voltage and current inputs are > 10% of range. The exception is harmonics where the specification is valid when the magnitude of the harmonic is > 2% of range.

Index

A

Accessories, xiv

C

Channel settings, 3, 4

Command listing, 63

Connect a current transformer, 28
current scaling, 28

Connect a resistive shunt, 29

Connect a transducer
with a voltage output, 30

Connect a voltage transducer, 31
voltage scaling, 31

Connect a voltage transformer, 31
voltage scaling, 31

Connecting signals, 26

Connecting to the product under
test, 4

D

Data format, 24

Data storage, 24

Datalog, 52

E

Examples

choosing measurements to
display, 8

communications, 91

harmonics, 92

return results repeatedly, 92

select and return result, 91

using a group of channels, 93

F

Features and abilities, xiii

basic features, xiii

Front panel

alphabetical buttons, 22

barchart screen, 14

equation buttons, 23

integrator screen, 16

layout, 11

math screen, 18

number buttons, 23

operation, 11

operational buttons, 22

quick view buttons, 11

results screen, 12

setup screen, 19

soft keys, 21

vector screen, 17

waveform screen, 13

G

Global

settings, 3

GPIO commands, 64

:ANA, 83

:AVG, 87

:BDW, 82

:BLK, 87

:CAL:DATE?, 67

:CFG:USER, 90

channel and group, 66

*CLS, 64

:COM:ETH, 84

:COM:ETH:MAC, 85

:COM:ETH:STAT, 84

:COM:IEE, 84

:COM;RS2, 83

communications

examples, 91

:DATA:USB, 85

datalog, 85

:DSE, 65

:DSE?, 65

:DSR?, 65

:DVC, 65

*ESE, 64

*ESE?, 64

*ESR?, 64

example using a group of
channels, 93

:FRD?, 71

:FRF?, 70

:FSR, 80

graph and waveform, 83

harmonics, 92

:HMX:VLT/AMP, 71

:HMX:VLT/AMP:DF, 72

:HMX:VLT?AMP:THD, 73

:HMX:VLT/AMP:TIF, 74

*IDN?, 64

input setup, 78

:INST:NSEL, 66

:INST:NSEL?, 66

:INST:NSELC, 66

:INST:NSELC?, 66

interface, 83

Math, 86

:MATH?, 86

:MATH:FUNC, 86

:MATH:FUNC:EN, 86

:MAX, 75

measurement

configuration, 71

measurement reading, 67

measurement selection, 67

:MIN, 74

:MOD, 76

:MOD:BAL, 76

:MOD:INT, 77

:MOD:PWM, 78

:MOD:SBY, 77

mode setup, 76

:MOVE, 70

:NAME, 79

return results repeatedly, 92

:RNG, 79

*RST, 65

:SCL, 82

:SEL, 68

select and return result, 91

- sending and receiving, 90
 - :SHU, 80
 - *STB?, 65
 - :SUM, 75
 - :SYST:CTYPE?, 67
 - :SYST:DATE, 88
 - :SYST:POWER, 89
 - :SYST:TIME, 89
 - :SYST:ZERO, 88
 - system configuration, 87
 - unit information
 - commands, 67
 - :UPDATE, 87
 - user configuration, 90
 - :WRG, 78
- Graphs and waveforms, 50
- integrator parameters, 50
 - waveforms, 50
- Group
- definition, 3
 - settings, 3
- I**
- IEEE 488.2
- standard commands, 64
 - status commands, 64
- Input
- current, 27
 - external current, 27
 - overview, 26
 - voltage, 27
- Inputs, 44
- analog inputs, 50
 - bandwidth, 48
 - external phase
 - compensation, 49
 - fixed/auto ranging, 47
 - frequency source, 47
 - ranges, 46
 - scale, 49
 - shunts, 47
 - wiring, 44
- Interfaces, 51
- Ethernet configure, 51
 - GPIB address, 51
 - printing, 51
 - RS232 baud rate, 51
- L**
- logging data, 24
- logging data to a memory device, 24
- M**
- Math, 52
- Measurements
- configuration, 37
 - default, 6
 - distortion set up, 37
 - harmonics set up, 37
 - maximum hold columns, 39
 - minimum hold columns, 39
 - SUM results column, 39
- Menu system, 33
- main menu, 33
 - measurements, 33
 - menu items, 33
 - navigation, 33
- Modes, 40
- ballast, 40
 - integrator, 41
 - normal, 40
 - PWM motor, 43
 - standby power, 41
- N**
- Navigating the menu system, 8
- Navigating the results screen, 7
- O**
- On screen help, 9
- P**
- Package contents, xiii
- Power for external transducers, 32
- Power on, 2
- R**
- Remote operation, 59
- Interfacing with Ethernet systems, 59
 - Interfacing with GPIB systems, 60
 - interfacing with RS232 systems, 59
 - Interfacing with USB systems, 59
 - overview, 59
- S**
- Safety Summary, vi
- Software, 94
- PA4000 download software, 94

- Specifications, 96
 - auxiliary inputs/outputs, 100
 - communications ports, 98
 - Ethernet port, 100
 - IEEE 488/GPIB, 98
 - serial port, 98
 - USB host, 99
 - USB peripheral, 99
 - host/client port, 101
 - measured parameters, 101
 - measurement accuracy, 104
 - measurement channel, 96
 - 1 A current
 - connection, 96
 - 30 A current
 - connection, 96
 - analog card power supply
 - outputs, 96
 - external current
 - connection, 96
 - voltage connections, 96
 - mechanical and
 - environmental, 97
 - dielectric strength, 97
 - dimensions, 97
 - humidity, 97
 - maximum operating
 - altitude, 97
 - operating temperature, 97
 - storage temperature, 97
 - weight, 97
 - optional parts, 97
 - GPIB, 97
 - transducer power
 - supply, 98
 - power supply, 97
- Status reporting, 60
 - display data status enable
 - register, 62
 - display data status register, 62
 - standard event status enable
 - register, 63
 - standard event status
 - register, 63
 - status byte, 60
 - status byte register, 61
- System configuration, 55
 - analyzer configuration, 57
 - auto zero, 56
 - averaging, 56
 - blanking, 55
 - clock, 56
 - host/client, 56
 - optional functionality, 57
 - power saving, 56
 - update rate, 56

U

- User configuration, 57